

---

**harman/kardon®**  
Power for the Digital Revolution.®

# DVD 101

DIGITAL VERSATILE DISC PLAYER  
OWNER'S MANUAL

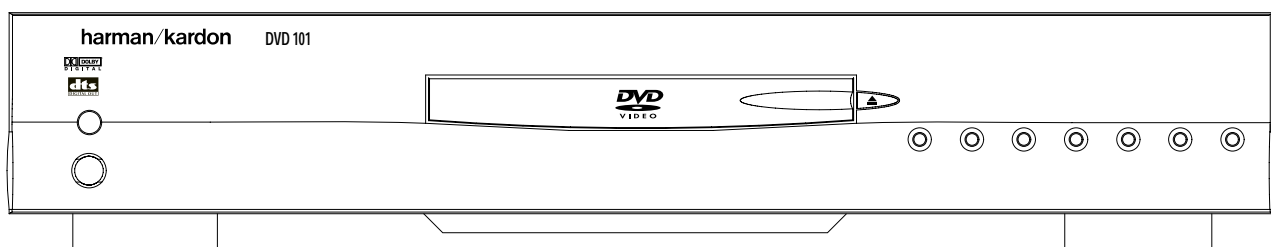

3	Introduction
4	Safety Information
5	Features & DVD Compatibility
6	DVD Terminology
7	Front-Panel Controls
8	Front-Panel Information Display
9	Remote Control Functions
11	Rear-Panel Connections
12	Setup and Connections
12	Connecting to a TV and Analog Receiver
13	Connecting to a Receiver/Amplifier With Dolby Digital or DTS Decoder
14	Connecting to a TV or Monitor With Component Connectors – Component Video Connection
15	Remote Control Operation
16	Digital Audio Connections
17	System Setup
17	System Defaults
17	Main Menu
17	Navigating Menus
17	Video Menu
18	Audio Menu
19	Player Setup Menu
20	Menu Language
21	Test Screen
22	Playback Basics for All Formats
23	DVD Playback
23	Using a DVD's Menu
23	Zoom Feature
23	Playback Resume Feature
24	Playing DVDs
24	Using the On-Screen Banner Display
24	Selecting a Title
24	Selecting a Chapter
24	Selecting the Audio Track
24	Selecting the Subtitle Language
24	Selecting an Angle
24	Selecting the Progressive Scan Format
25	Changing the Audio Track
25	Changing the Subtitle Language
25	Changing the Camera Angle
25	Repeat Play
26	A-B Repeat Play
26	Zoom Playback
26	Information Menus
27	Programmed Play With DVD
28	CD Playback
28	Audio CD Playback Features
28	Selecting a Track
28	Using Bookmarks
28	Selecting Time Display
29	Repeat Play
29	Random Play
29	Video Off Feature
30	Programmed Play With CD
31	MP3 Disc Playback
32	VCD Playback
33	DVD Language Codes
34	Troubleshooting Guide
35	Technical Specifications

See trademark acknowledgements on page 35.

## Typographical Conventions

In order to help you use this manual with the remote control, front-panel controls and rear-panel connections, certain conventions have been used.

**EXAMPLE** – (bold type) indicates a specific remote control or front-panel button or indicator, or rear-panel connection jack

**EXAMPLE** – (OCR type) indicates a message that is visible on the front-panel information display

**1** – (number in a square) indicates a specific front-panel control

**1** – (number in an oval) indicates a button or indicator on the remote control

**1** – (number in a circle) indicates a rear-panel connection

**A** – (letter in a square) indicates an indicator in the front-panel information display

## Thank you for choosing the Harman Kardon® DVD 101.

The DVD 101 is a multipurpose DVD player that delivers the highest level of playback quality from a wide range of optical media formats. Along with conventional DVD and CD audio discs, the DVD 101 is also compatible with CD-R and CD-RW discs, VCD discs and discs recorded with audio files in the MP3 format.

On the video side, the DVD 101 offers progressive scan video outputs for use with digital "HDTV-Ready" display monitors. Using a high-speed, single-chip digital processor, the DVD 101 is capable of reconstructing the 3/2 pulldown effect introduced when film-based programs are transferred to video. In conjunction with precision video output DACs, the end result is a full 60-frame-per-second image that is the closest thing to film this side of your local cinema. Of course, conventional Y/Pr/Pb component video, S-Video and composite video outputs are also available for use with analog televisions and video projectors.

In keeping with our tradition as a leader in audio technology, Harman Kardon has packed the DVD 101 with the latest features, including audiophile-grade Wolfson audio output DACs and full compatibility with 96kHz audio programming. Both coaxial and optical digital outputs are available for direct connection to A/V receivers or surround processors so that you may take advantage of Dolby® Digital and DTS® soundtracks. Finally, built-in MP3 decoding allows music discs created and finalized on a computer to be played back through your home theater system for increased listening pleasure.

When playing DVDs, easy-to-understand on-screen menus and icons make it simple to change languages, soundtracks, subtitles or aspect ratio, while a parental-lock function enables you to control which discs may be viewed by younger members of the household.

DVD players are among the fastest growing consumer electronics products ever brought to market, so this may be the first DVD player you've owned. Although many of the features of the DVD 101 resemble those of standard CD changers or players, there are a number of functions that you may be unfamiliar with. To ensure that you are able to take advantage of all the power and flexibility the DVD 101 has to offer, we encourage you to review this manual. That small investment of your time will pay major dividends in the enjoyment you will get from proper use of the DVD 101.

If you have additional questions about this product, or its installation or operation, that are not answered in this manual, please contact your dealer, as he or she is your best source of local information. You may also contact Harman Kardon via e-mail through our Web site at [www.harmankardon.com](http://www.harmankardon.com).

- Plays a Wide Range of Video and Audio Formats, Including DVD-Movie Discs, VCD, Standard CD Audio Discs, CD-R/RW Audio Discs and MP3 Discs
- High-Quality Video Playback 10-Bit DACs, Progressive Scan and Component Video Outputs
- Dolby® Digital and DTS® Data Signal Output Through Both Optical and Coaxial Digital Audio Connections
- Audiophile-Grade Wolfson Output DACs for the Finest Audio Reproduction
- Easy-to-Use On-Screen Navigation System
- Playback of MP3 Audio Discs With Text Display
- Extensive Programming Capability for Audio and Video Discs
- Parental Lock Controls Prevent Unauthorized Viewing of Restricted Movies
- Multiple Options for Language, Soundtrack and Subtitle Selection
- Multiple-Angle Capabilities With Specially Encoded DVD Discs
- Backlit, Ergonomically Designed Remote Control

**NOTE:** This player is designed and manufactured for compatibility with Region Management Information that is encoded on most DVD discs. This player is designed only for playback of discs with Region Code 1, or for discs that do not contain Region Code information. If there is any other Region Code on a disc, that disc will not play on the DVD 101.

**CAUTION**

**RISK OF ELECTRIC SHOCK  
DO NOT OPEN**

**CAUTION:** To prevent electric shock, do not use this (polarized) plug with an extension cord, receptacle or other outlet unless the blades can be fully inserted to prevent blade exposure.

 The lightning flash with arrowhead symbol, within an equilateral triangle, is intended to alert the user to the presence of uninsulated "dangerous voltage" within the product's enclosure that may be of sufficient magnitude to constitute a risk of electric shock to persons.

 The exclamation point within an equilateral triangle is intended to alert the user to the presence of important operating and maintenance (servicing) instructions in the literature accompanying the appliance.



# SAFETY INFORMATION

## Verify Line Voltage Before Use

Your DVD 101 has been designed for use with 120-volt AC current and the plug is specifically designed for 120-volt applications. Connection to a line voltage other than that for which it is intended can create a safety and fire hazard and may damage the unit.

If you have any questions about the voltage requirements for your specific model, or about the line voltage in your area, contact your selling dealer before plugging the unit into a wall outlet.

## Do Not Use Extension Cords

We do not recommend that extension cords be used with this product. As with all electrical devices, do not run power cords under rugs or carpets or place heavy objects on them. Damaged power cords should be replaced immediately by an authorized service center with cords meeting factory specifications.

## Handle the AC Power Cord Gently

When disconnecting the power cord from an AC outlet, always pull the plug; never pull the cord. If you do not intend to use the unit for any considerable length of time, disconnect the plug from the AC outlet.

## Do Not Open the Cabinet

There are no user-serviceable components inside this product. Opening the cabinet may present a shock hazard, and any modification to the product will void your guarantee. If water or any metal object such as a paper clip, wire or a staple accidentally falls inside the unit, disconnect it from the AC power source immediately, and consult an authorized service center.

## Installation Location

- To ensure proper operation, and to avoid the potential for safety hazards, place the unit on a firm and level surface. When placing the unit on a shelf, be certain that the shelf and any mounting hardware can support the weight of the product.
- Make certain that proper space is provided both above and below the unit for ventilation. If this product will be installed in a cabinet or other enclosed area, make certain that there is sufficient air movement within the cabinet.
- Do not place the unit directly on a carpeted surface.
- Avoid moist or humid locations.
- Avoid installation in extremely hot or cold locations, or an area that is exposed to direct sunlight or heating equipment.
- Do not obstruct the ventilation slots on the top of the unit, or place objects directly over them.

## Cleaning

When the unit gets dirty, wipe it with a clean, soft, dry cloth. If necessary, wipe it with a soft cloth dampened with mild soapy water, then a fresh cloth with clean water. Wipe immediately with a dry cloth. NEVER use benzene, aerosol cleaners, thinner, alcohol or any volatile cleaning agent. Do not use abrasive cleaners, as they may damage the finish of metal parts. Avoid spraying insecticide near the unit.

## Unpacking

The carton and shipping materials used to protect your new receiver during shipment were specially designed to cushion it from shock and vibration. We suggest that you save the carton and packing materials for use in shipping if you move, or should the unit ever need repair.

To minimize the size of the carton in storage, you may wish to flatten it. This is done by carefully slitting the tape seams on the bottom, and collapsing the carton down to a more two-dimensional appearance. Other cardboard inserts may be stored in the same manner. Packing materials that cannot be collapsed should be saved along with the carton in a plastic bag.

If you do not wish to save the packaging materials, please note that the carton and other sections of the shipping protection are recyclable. Please respect the environment and discard those materials at a local recycling center.

## Remove Front-Panel Protective Film

In order to protect the lens covering the front panel of your new DVD 101, it is shipped from the factory covered by a protective plastic film. Before using the unit, remove this film by grabbing one corner and gently peeling back the plastic sheet. Note that the film must be removed for proper operation of the remote control.

## Moving the Unit

Before moving the unit, be certain to disconnect any interconnection cords with other components, and make certain that you disconnect the unit from the AC outlet.

**IMPORTANT NOTE:** To avoid damage to the DVD 101 that may not be covered by the warranty, be certain that the disc is removed from the unit before it is moved. Once the DVD 101 is installed, a disc may be left in the unit when it is turned off, but the unit should NEVER be moved with a disc left in the disc tray.

## Important Information for the User

This equipment has been tested and found to comply with the limits for a Class B digital device, pursuant to Part 15 of the FCC Rules. The limits are designed to provide reasonable protection against harmful interference in a residential installation. This equipment generates, uses and can radiate radio-frequency energy and, if not installed and used in accordance with the instructions, may cause harmful interference to radio communication. However, there is no guarantee that harmful interference will not occur in a particular installation. If this equipment does cause harmful interference to radio or television reception, which can be determined by turning the equipment off and on, the user is encouraged to try to correct the interference by one or more of the following measures:

- Reorient or relocate the receiving antenna.
- Increase the separation between the equipment and receiver.
- Connect the equipment into an outlet on a circuit different from that to which the receiver is connected.
- Consult the dealer or an experienced radio/TV technician for help.

This device complies with Part 15 of the FCC Rules. Operation is subject to the following two conditions: (1) this device may not cause harmful interference, and (2) this device must accept interference received, including interference that may cause undesired operation.

**NOTE:** Changes or modifications may cause this unit to fail to comply with Part 15 of the FCC Rules and may void the user's authority to operate the equipment.

**CAUTION:** The DVD 101 uses a laser system. To prevent direct exposure to the laser beam, do not open the cabinet enclosure or defeat any of the safety mechanisms provided for your protection. DO NOT STARE INTO THE LASER BEAM. To ensure proper use of this product, please read this Owner's Manual carefully and retain it for future use. Should the unit require maintenance or repair, please contact your local Harman Kardon service center. Refer servicing to qualified personnel only.

## High-Quality Video

- Advanced sophisticated 10-bit MPEG-2 video decoding circuits.
- Test-screen signal for testing video performance and setup.
- Progressive Scan component video outputs.

## High-Quality Digital Audio

- By connecting a digital processor or receiver, you may enjoy high-quality 5.1 digital surround sound from DTS or Dolby Digital discs.
- With linear PCM audio at 16–24 bits and 44kHz – 96kHz (also on digital output, see table on page 16), audio quality exceeding that of CD becomes possible.
- Optical and coaxial digital audio outputs.

## Many Convenient Features

- On-screen menu icons for disc information or player information and access to many major functions of this unit.
- Subtitles may be displayed in one of numerous languages†
- The multi-angle function allows you to choose the viewing angle of scenes that were shot from a number of different angles (limited to DVDs recorded with multiple camera angles).
- Multiple options for dialogue language and soundtrack selection (limited to DVDs recorded with multiple dialogue languages or soundtracks).
- Parental lock settings to prevent play of discs unsuitable for some audiences (DVD only).
- Intuitive menu operating system.
- Separate buttons for convenient Fast Forward/Fast Reverse Search and Track Skip.
- Zoom during Play and Pause.
- Backlit, ergonomically designed remote control.

† The number of languages depends on the information available on each individual DVD.

## Compatible With CD as Well as DVD

- The DVD 101 will play any conventional Audio CD and most recordable (CD-R) or erasable (CD-RW) CDs, bearing the logos shown here, MP3 or any VCD or DVD with the Region Code 1.

## Disc Formats Supported by This Player

The unit can play the following types of discs:



<b>DVD</b>	<b>CD</b>
3" (8cm) disc	3" (8cm) disc
5" (12cm) disc	5" (12cm) disc

The DVD 101 will also play most discs recorded in the DVD-RW or DVD+RW formats, but we cannot guarantee complete playback compatibility of DVD-recordable discs due to the wide variation in recorders and blank discs.



<b>CD-RW</b>	<b>CD-R</b>	<b>VCD</b>
5" (12cm) disc	3" (8cm) disc	5" (12cm) disc
	5" (12cm) disc	5" (12cm) disc

**NOTE:** Playback of CD-R or CD-RW discs created on a computer requires proper formatting and finalization of the disc for audio playback. Some computers and/or software programs may not be capable of creating compatible discs.

However, it will NOT play the following:

- DVD discs with a Region Code other than 1
- DVD discs with PAL format video
- DVD-ROM data discs
- DVD-RAM discs
- CD-I discs
- CD-G discs
- SVCD discs
- Photo CD discs

**NOTE:** Due to differences in the formatting of certain discs, it is possible that some discs may include features that are not compatible with the DVD 101. Similarly, although the DVD 101 is capable of a wide range of features, not all discs include every capability of the DVD system. For example, although the DVD 101 is compatible with multi-angle discs, that feature is only possible when the disc is specially encoded for multiple-angle play. In addition, the DVD 101 is capable of playing back both Dolby Digital and DTS soundtracks, but the number and types of tracks available will vary from disc to disc. To make certain that a specific feature or soundtrack option is available, please check the options noted on the disc jacket.

- Playback of DTS audio discs requires connection to a processor or receiver with a DTS decoder.
- Playback capability for CD- or DVD-recordable discs may vary due to variations in the quality of the disc and the recorder used to create the disc.

## Packing List

- 1 Harman Kardon DVD 101 DVD Player
- 1 Remote control
- 2 AA batteries
- 1 A/V cable for stereo analog audio and composite video
- 1 S-Video cable
- 1 Owner's manual

# DVD TERMINOLOGY

Since they share some of the characteristics and technology of CD players, many of the terms and operational concepts used in a DVD player are similar to what you may be familiar with from CD players and changers, or older video disc formats such as Laser Disc. However, if this is your first DVD product, some of the terms used to describe the features of a DVD player may be unfamiliar. The following explanations should solve some of the mysteries of DVD, and help you to enjoy all the power and flexibility of the DVD format and the DVD 101.

**Aspect Ratio:** This is a description of the width of a video image in relation to its height. A conventional video screen is four units wide for every three units of height, making it almost square. Newer wide-aspect-ratio video displays are 16 units wide for every nine units of height, making them more like the screen in a movie theater. The program material on a DVD may be recorded in either format and, in addition, you may configure the DVD 101 to play back in either format, depending on the features recorded on a disc.

**Chapter:** DVD programs are divided into chapters and titles. Chapters are the subsections programmed into a single title on a disc. Chapters may be compared to the individual tracks on an audio CD. Press the **Menu Button 12** to see a listing of the chapters on a disc.

**Component Video:** This form of video signal eliminates many of the artifacts of traditional composite video signals by splitting the signal into a separate luminance channel (the "Y" signal channel) and two color-difference signals (the Pr and Pb signal channels). With a component video connection, you will see greater picture resolution and eliminate many picture imperfections such as the moiré patterns often seen on check-patterned cloth. However, in order to benefit from component video you must have a video display with Y/Pr/Pb component video inputs. Do not connect the component video outputs of the DVD 101 to the standard composite or S-Video inputs of a TV or recorder.

**Title:** For a DVD, a title is defined as an entire movie or program. There may be as many chapters within a title as the producers decide to include. Most discs include only one title, but some may have more than one, to give you a "Double Feature" presentation or to include other special features. Press the **Title Button 4** to see a listing of the titles on a disc. When a disc has only one title, pressing the **Title Button 4** may show a list of the chapters.

**Multiple Angle:** DVDs have the capability to show up to four different views of the same scene in a program. When a disc is encoded with multiple-angle information, pressing the **Angle Button 5** will enable you to switch between these different views. Note that, at present, few discs take advantage of this capability and, when they do, the multiple-angle technology may only be present for short periods of time within the disc. Producers will usually insert some sort of icon or graphic in the picture to alert you to the availability of multiple-angle scenes.

**Reading:** This is a message that you will see when you first press the **Play Button 4 17**. It refers to the fact that the player must first examine the contents of the disc to see whether it is a CD or DVD, and then extract the information about the type of material on the disc, such as languages, aspect ratios, subtitles, number of titles and more. The slight delay while the contents of the disc are read is normal.

**Resume:** The operation of the **Stop Button 6 19** on the DVD 101 works differently from what you are used to on CD players. On a traditional CD player, when you press the Stop button, the unit does just that: it stops playback. On a CD player, when you press the Start button again, the disc starts from the beginning. With the DVD 101, however, you have two options when playing DVD discs. Pressing the **Stop Button 6 19** once will stop the playback, but it actually puts the unit in the Resume mode. This means that you can turn the machine off and, when you press the **Play Button 4 17** the next time, the disc will resume or continue from the point on the disc where the **Stop Button 6 19** was pressed. This is helpful if you are watching a movie and must interrupt your viewing session but wish to pick up where you left off. Pressing the **Stop Button 6 19** twice will stop the machine in a traditional manner and, when the disc is played again, it will start from the beginning.

# FRONT-PANEL CONTROLS

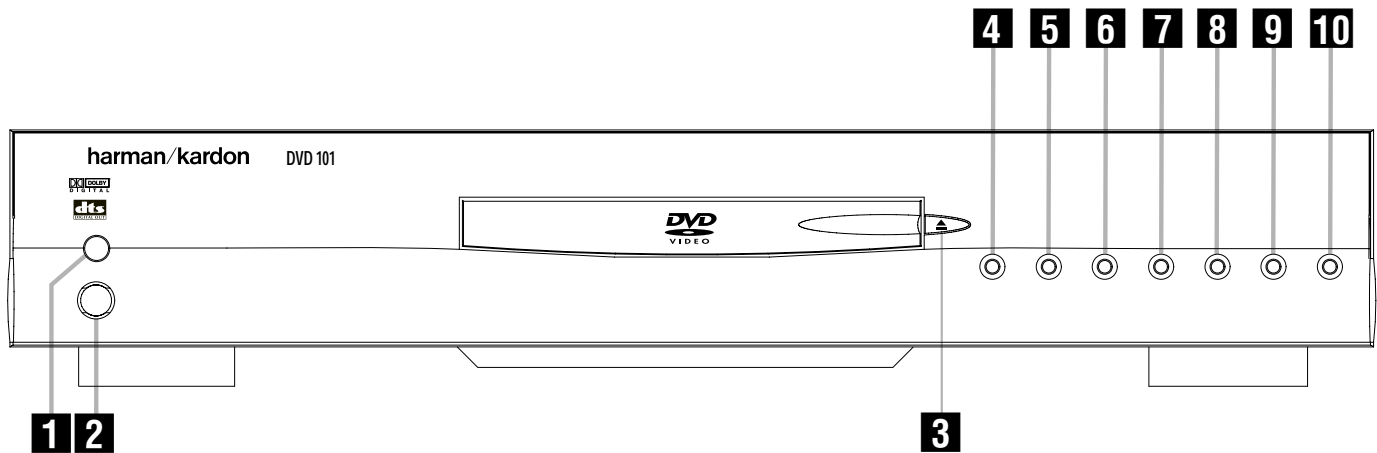

- 1** Main Power On/Off
- 2** Power On/Off (Standby)
- 3** Eject
- 4** Play

- 5** Pause
- 6** Stop
- 7** Skip (Previous)
- 8** Skip (Next)

- 9** Dimmer
- 10** Test

**1 Main Power On/Off:** Press this switch to apply power to the DVD 101. Once the unit has been turned on with this switch, it may be operated from either the front panel or remote control. Press the switch again to turn the unit completely off.

**2 Power On/Off (Standby):** Press the Button once to turn the DVD 101 on. Press it again to put the unit in the Standby mode. Note that in order for this switch to operate, the **Main Power Switch 1** must be pressed in so that it is in the ON position.

**3 Eject:** Press this Button to open or close the Disc Tray.

**4 Play:** Press to initiate playback or to resume playback after the **Pause Button 5** **13** has been pressed.

**5 Pause:** Press this Button to momentarily pause playback. To resume playback, press the button again. If a DVD is playing, action will freeze and a still picture will be displayed when the button is pressed.

**6 Stop:** Press this button once to place the disc in the Resume mode, which means that playback will stop, but as long as the tray is not opened or the disc changed, DVD playback will continue from the same point on the disc when the **Play Button 4** **17** is pressed again. Resume will also work if the unit was turned off. To stop a disc and have play start from the beginning, press the button twice.

**7 Skip (Previous):** Press this button to move backward through the music tracks on a CD disc or the chapters on a DVD disc.

**8 Skip (Next):** Press to move forward through the music tracks on a CD or the chapters on a DVD disc.

**9 Dimmer:** Press this button to reduce the brightness of the Information Display by 50% or to turn the display off completely in the following order: FULL BRIGHTNESS → HALF BRIGHTNESS → OFF → FULL BRIGHTNESS.

**10 Test:** Press this button to bring a test picture to the screen, which enables you to optimally adjust all important parameters of color videos, such as brightness, contrast, color intensity and tint.

# FRONT-PANEL INFORMATION DISPLAY

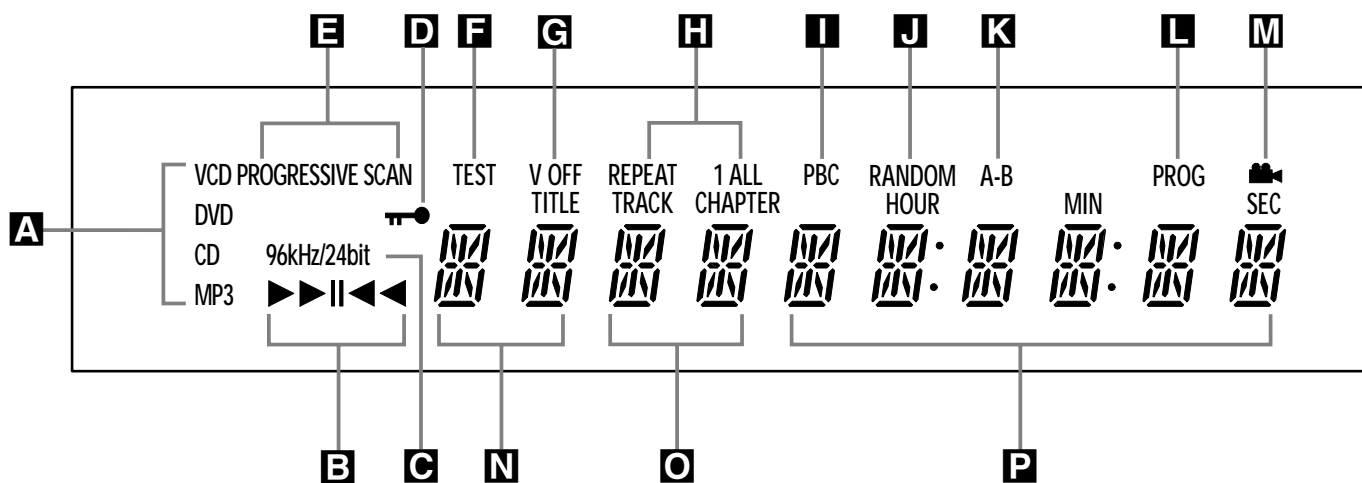

- A** Disc-Type Indicators
- B** Playback-Mode Indicators
- C** 96kHz/24-Bit Indicator
- D** Parental Lock Indicator
- E** Progressive Scan Indicator
- F** Test Indicator
- G** V-OFF Indicator
- H** Repeat Indicator
- I** VCD Playback Control Indicator
- J** Random Indicator
- K** A-B Repeat Indicator
- L** Program Indicator
- M** Angle Indicator
- N** Title Indicators
- O** Chapter/Track Number Indicators
- P** Time Indicators

**A** **Disc-Type Indicators:** The DVD, VCD, CD or MP3 indicator will light to show the type of disc currently being played.

**B** **Playback-Mode Indicators:** These indicators light to show the current playback mode:

▶ Lights when a disc is playing in the normal mode.

▶▶ Lights when the disc is in the Fast Search Forward mode. The on-screen banner display indicates the selected speed, which may be selected by pressing the **Search Forward** or **Reverse Buttons** 18 20.

▶▶ Lights when the disc is paused.

◀◀ Lights when the disc is in the Fast Search Reverse mode. The on-screen banner display indicates the selected speed, which may be selected by pressing the **Search Forward** or **Reverse Buttons** 18 20.

**C** **96kHz/24-Bit Indicator:** The 96kHz indicator will light when a disc recorded with 96kHz content is playing; the 24-Bit indicator will light when a disc recorded with 24-bit content is playing.

**D** **Parental Lock Indicator:** This indicator lights when the parental lock system is engaged in order to prevent anyone from changing the rating level without a code.

**E** **Progressive Scan Indicator:** Lights when Progressive Scan component video output is selected in the setup menu.

**F** **Test Indicator:** This indicator lights when the TV test screen is activated.

**G** **V-OFF Indicator:** This indicator lights when the unit's video output has been turned off by pressing the **Video Off Button** 27 on the remote control.

**H** **Repeat Indicators:** These indicators light when any of the Repeat functions are in use.

**I** **VCD Playback Control Indicator:** This indicator lights when the playback control function is turned on with VCDs.

**J** **Random Indicator:** This indicator lights when the unit is in the Random Play mode.

**K** **A-B Repeat Indicator:** This indicator lights when a specific passage for repeat playback has been selected.

**L** **Program Indicator:** This indicator lights when the programming functions are in use.

**M** **Angle Indicator:** This indicator blinks when alternative viewing angles are available on the DVD currently playing.

**N** **Title Indicators:** These two positions in the display will show the current title number when a DVD disc is playing.

**O** **Chapter/Track Number Indicators:** When a DVD disc is playing, these two positions in the display will show the current chapter. When a CD disc is playing they will show the current track number.

**P** **Time Indicators:** These positions in the indicator will show the running time of a DVD in play. When a CD is playing, these indicators will show the current track time, time remaining in the current track or the total remaining time on the disc.

**NOTE:** The indicators **NOP** will also display text messages about the DVD 101's status, including **Reading** when a disc is loading, and **Disc Error** when a disc not compatible with the DVD 101 is put into the Play position.



# REMOTE CONTROL FUNCTIONS

- ➊ Power On
- ➋ Power Off
- ➌ Subtitle
- ➍ Title
- ➎ Angle
- ➏ Audio
- ➐ Test
- ➑ Eject
- ➒ Setup
- ➓ Navigation Buttons
- ➑ Info
- ➑ Menu
- ➑ Pause
- ➑ Status
- ➑ Skip (Previous)
- ➑ Skip (Next)
- ➑ Play
- ➑ Search Reverse
- ➑ Stop
- ➑ Search Forward
- ➑ Dimmer
- ➑ Slow Forward
- ➑ Zoom
- ➑ Slow Reverse
- ➑ Random
- ➑ Step Forward
- ➑ Video Off
- ➑ Step Reverse
- ➑ Numeric Keys
- ➑ Program
- ➑ Check
- ➑ Clear
- ➑ Repeat
- ➑ Light
- ➑ A-B Repeat

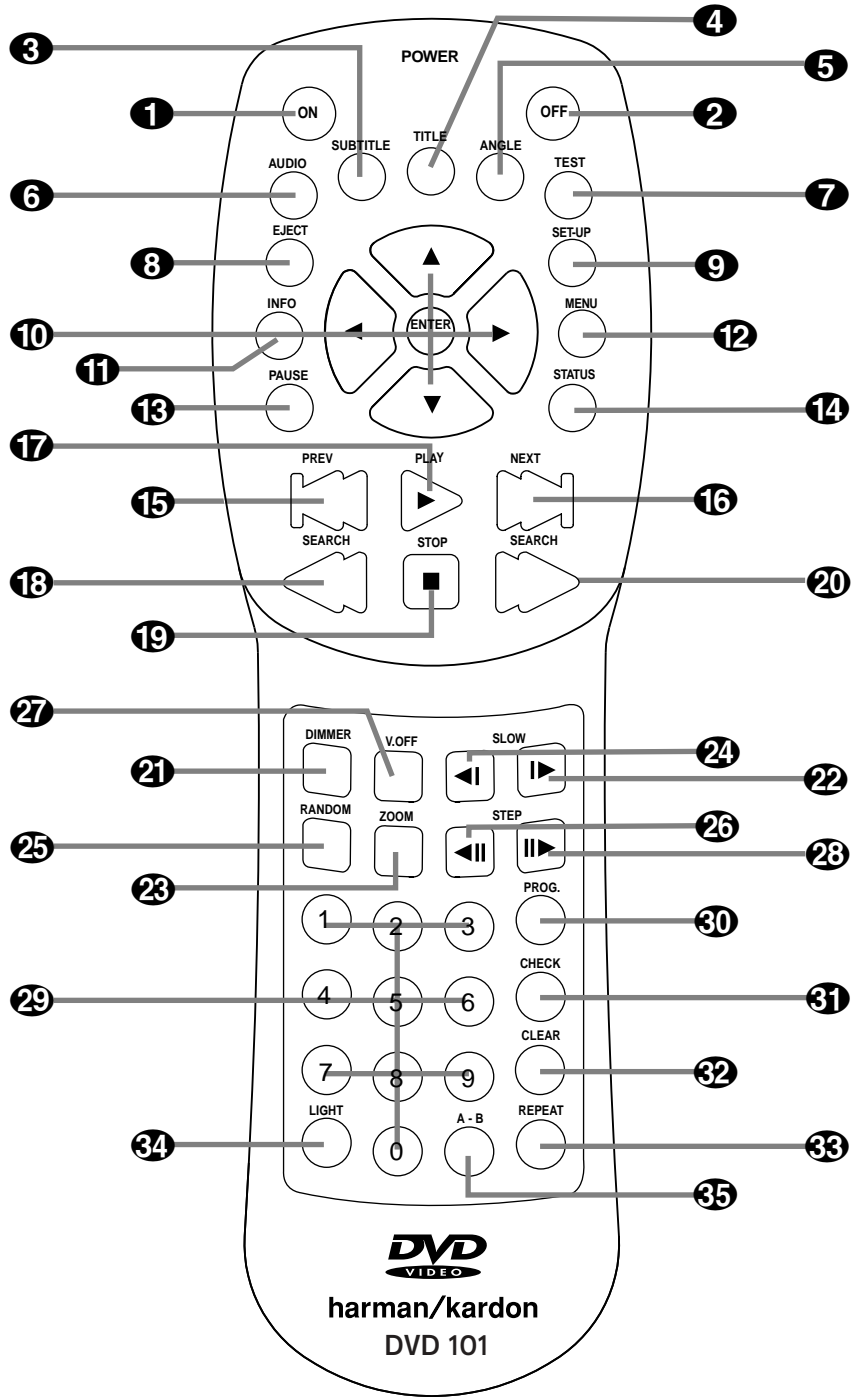

# REMOTE CONTROL FUNCTIONS

- 1 Power On:** Turns on the player when it is in Standby mode (the **Harman Kardon** logo appears on-screen).
- 2 Power Off:** Turns off the player to Standby mode.
- 3 Subtitle:** When a DVD is playing, press to select a subtitle language or to turn subtitles off.
- 4 Title:** When a disc is playing, press to jump to the subsequent title (with the next title number) on the disc.
- 5 Angle:** Press to access various camera angles on a DVD (if the DVD contains multiple camera angles).
- 6 Audio:** Press to access various audio languages on a DVD (if the DVD contains multiple audio streams).
- 7 Test:** Press for the on-screen test pattern which enables you to optimally adjust brightness, contrast, color intensity, etc., of your display device.
- 8 Eject:** Press to open or close the disc tray.
- 9 Setup:** Press to access player setup menu.
- 10 Navigation Buttons (◀▶▲/▼/Enter):** Use to select and execute items or settings.
- 11 Info:** Press once for detailed information on the disc playing (Video/Audio bit rate, Movie aspect ratio and others). Press again for current player settings. Note that the unit will not react to any transport button as long as the info menu is displayed. Press again to remove information from screen.
- 12 Menu:** Displays the DVD disc menu on the TV screen in Play mode.
- 13 Pause:** Freezes a picture (with DVD/VCD) and pauses the playback signal (CD) when a disc is playing. Press again for normal playback.
- 14 Status:** Press while a disc is playing to view the on-screen status banner display. Use the ◀▶ Navigation Buttons **10** to move through the different features in the Banner Display. When a symbol is highlighted, press the **Enter Button 10** on the remote to select it.
- 15 Skip (Previous):** Press to go to beginning of current track. Press again quickly to go to beginning of previous track.
- 16 Skip (Next):** Press to go to beginning of next track.
- 17 Play:** Begins to play disc (closes disc tray first, if it is open).
- 18 Search (Rev):** Allows you to search in reverse through a disc while it is in Play mode. Each time you press this button while a DVD is playing, the search speed changes as below:  
R. SEARCH 2x → R. SEARCH 4x → R. SEARCH 8x → R. SEARCH 16x → R. SEARCH 2x
- When a CD is playing, there are two fast-play speeds:  
R. SEARCH 5x → R. SEARCH 15x
- 19 Stop:** Stops playing a disc. When a disc is playing, if you press the **Stop Button 6 19** and the **Play Button 4 17**, the disc will resume play; i.e., it will start from the same point on the disc where the unit was stopped. If you press the **Stop Button 6 19** twice and the **Play Button 4 17**, the disc will start play from the beginning.
- 20 Search (Fwd):** Allows you to search forward through a disc while it is in Play mode. Each time you press this button while a DVD is playing, the search speed changes as below:  
F. SEARCH 2x → F. SEARCH 4x → F. SEARCH 8x → F. SEARCH 16x → F. SEARCH 2x
- When a CD is playing, there are two fast-play speeds:  
F. SEARCH 5x → F. SEARCH 15x
- 21 Dimmer:** Press to change the brightness of the front-panel display or to turn the display off completely in the following order: FULL BRIGHTNESS → HALF BRIGHTNESS → OFF → FULL BRIGHTNESS
- 22 24 Slow:** Allows you to play movies in Slow mode. Each time you press this button while a DVD is playing, the slow speed will be changed as below:  
F. SLOW 1/2x → F. SLOW 1/4x → F. SLOW 1/8x → F. SLOW 1/16x → F. SLOW 1/2x  
R. SLOW 1/2x → R. SLOW 1/4x → R. SLOW 1/8x → R. SLOW 1/16x → R. SLOW 1/2x
- Slow-speed playback is not available for CDs.
- 23 Zoom:** When a DVD or VCD is playing, press this button to zoom the picture so that it is enlarged. There are four steps to the zoom function, each progressively larger. Press through each of the zoom stages to return to a normal picture.
- 25 Random:** Press for Random playback in random order.
- 26 28 Step (Rev/Fwd):** Freeze a picture when a disc is playing. Also, the picture advances frame by frame each time this button is pressed.
- 27 Video Off:** Press to turn off video output for improved audio performance from CDs. Press again to restore video output (see page 29).
- 29 Numeric Keys:** Select numbers by pressing these buttons.
- 30 Prog:** When programming playlists and the unit is in the Stop mode, press this button to view the Program Edit display.
- 31 Check:** Press during program play (in Resume mode) to check the program status on the front-panel display. Escape from this display by pressing the **Play Button 4 17**.
- 32 Clear:** Press to remove the On-Screen Banner Display from the screen.
- 33 Repeat:** Press to go to the Repeat menu. You can repeat a chapter, track or the entire disc.
- 34 Light:** Press to illuminate the remote controller.
- 35 A-B:** Press to select section A-B and to play repeatedly.

# REAR-PANEL CONNECTIONS

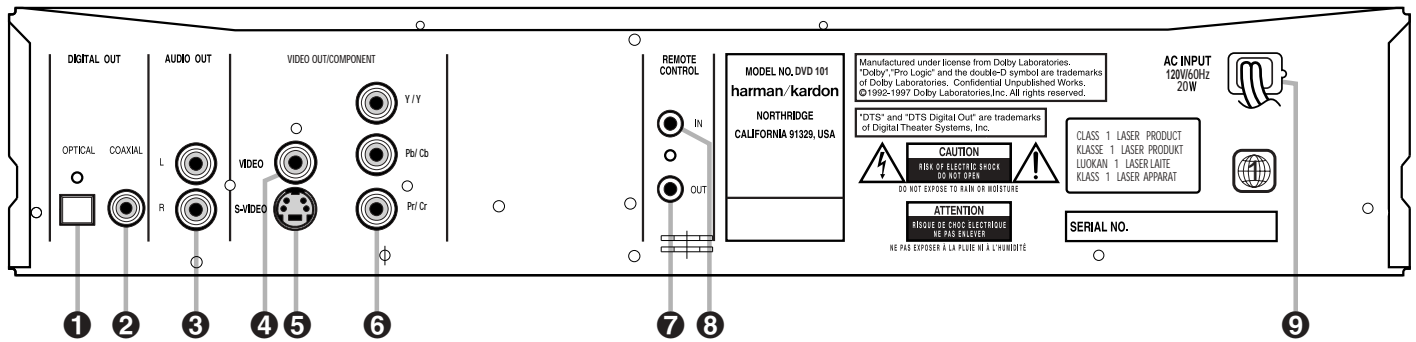

- ❶ Optical Digital Output
- ❷ Coaxial Digital Output
- ❸ Analog Audio Outputs
- ❹ Composite Video Output

- ❺ S-Video Output
- ❻ Component Video Outputs
- ❼ Remote Control Output
- ❽ Remote Control Input

- ❾ AC Power Cord

**❶ Optical Digital Output:** Connect this jack to the optical digital input of an A/V receiver or surround processor for Dolby Digital, DTS or PCM audio playback.

**❷ Coaxial Digital Output:** Connect this jack to the coaxial digital input of an A/V receiver or surround processor for Dolby Digital, DTS or PCM audio playback.

**NOTE:** The coaxial digital output should only be connected to a digital input. Even though it is the same RCA-type connector as standard analog audio connections, **DO NOT** connect it to a conventional analog input jack.

**❸ Analog Audio Outputs:** Connect these jacks to an audio input on an A/V receiver or surround processor for analog audio playback.

**❹ Composite Video Output:** Connect this jack to the video input on a television or video projector, or to a video input on an A/V receiver or processor if you are using that type of device for video input switching.

**❺ S-Video Output:** Connect this jack to the S-Video input on a television or video projector, or to an S-Video input on an A/V receiver or processor if you are using that type of device for S-Video input switching.

**❻ Component Video Outputs:** These outputs carry the component video signals for connection to display monitors with component video inputs. For standard analog TVs or projectors with inputs marked Y/Pr/Pb or Y/Cr/Cb, connect these outputs to the corresponding inputs. If you have a high-definition television or projector that is compatible with high-scan-rate progressive video, connect these jacks to the HD component inputs. If you are using a progressive scan display device, PROGRESSIVE must be selected in the Video menu in order to take advantage of the progressive scan circuitry. See "Scan Type" section on page 17 for more information on progressive scan video.

**IMPORTANT:** These jacks should NOT be connected to standard composite video inputs.

**❼ Remote Control Output:** Connect this jack to the infrared (IR) input jack of another compatible Harman Kardon remote-controlled product to have the built-in Remote Sensor on the DVD 101 provide IR signals to other compatible products.

**❽ Remote Control Input:** Connect the output of a remote infrared sensor, or the remote-control output of another compatible Harman Kardon product, to this jack. This will enable the remote control to operate even when the front-panel Remote Sensor on the DVD 101 is blocked. This jack may also be used with compatible IR remote-control-based automation systems.

**❾ AC Power Cord:** Connect this plug to an AC outlet. If the outlet is controlled by a switch, make certain that it is in the ON position.

**NOTE:** You'll find more details about all audio/video connections under Setup and Connections on the following pages.

# SETUP AND CONNECTIONS

- Ensure that the power switch of this unit (and of other equipment to be connected) is set to "Off" before commencing connection.
- Do not block the ventilation holes of any of the equipment and arrange them so that air can circulate freely.
- Read through the instructions before connecting other equipment.
- Ensure that you observe the color-coding when connecting audio and video cables.

## Connecting to a TV and Analog Receiver

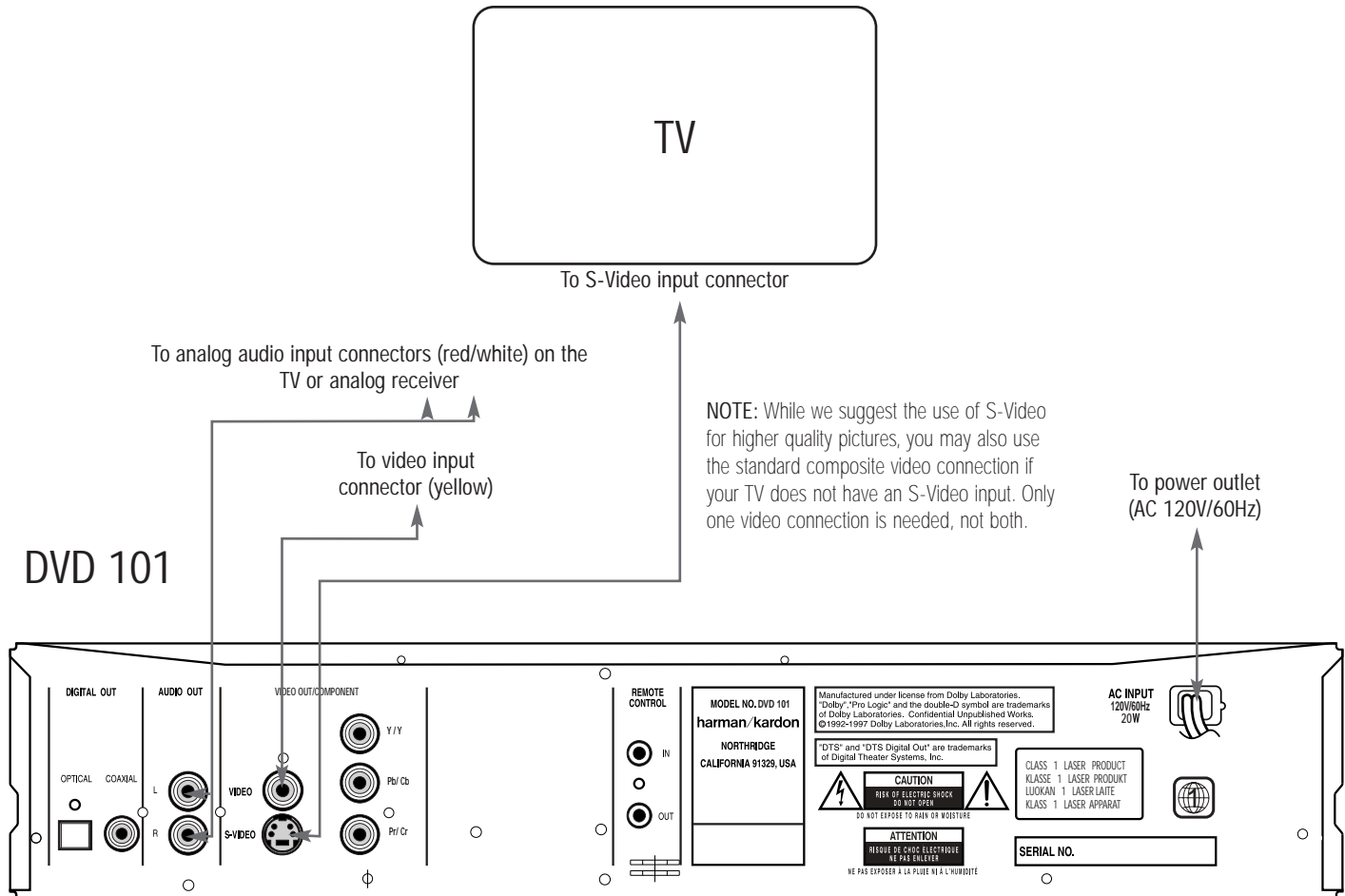

**NOTE:** While we suggest the use of S-Video for higher quality pictures, you may also use the standard composite video connection if your TV does not have an S-Video input. Only one video connection is needed, not both.

### NOTES:

- The video output (yellow) combines the complete video signal (composite) and sends it to the TV (or to the A/V receiver) by one cable only. Use the video output when your TV set is equipped with a video input jack only.
- The S (separate) video output connector separates the color (C) and luminance (Y) signals before transmitting them to the TV set in order to achieve a sharper picture. Use the S-Video cable when connecting the player to a TV equipped with an S-Video input for improved picture clarity. Never connect both outputs, video and S-Video, to your TV or A/V receiver; use only one of them.
- When the audio signal is to be fed to an analog receiver rather than to the TV, connect the audio out jacks to any normal audio input on your amplifier/decoder/receiver. The DVD 101 will "downmix"

Dolby Digital recordings to Pro Logic®, available on these connectors; all analog surround or stereo signals will be fed to them directly. You can also select the audio and video signals of all your video devices with your A/V receiver/amplifier. For more information see the "NOTE" on next page.

## Connecting to a Receiver/Amplifier With Dolby Digital or DTS Decoder

When DVDs encoded in Dolby Digital or DTS are played, the Dolby Digital or DTS bitstream is outputted from the player's optical or coaxial digital audio output. When the player is connected to a Dolby Digital or DTS decoder, you can enjoy theater-quality audio in your home. An optical digital audio cable or coaxial audio cable (both optional) is required for these connections, as shown below. Only one connection is needed, not both at the same time.

• **NOTE:** With multiple video sources, your audio/video device can be used for selecting the video signal and routing it to the TV. Connect the video or S-Video output of the DVD 101 (whatever is provided with your device) to the video or S-Video input on your device, and the video/S-Video output of this device to your TV. For more details, see the manual of your audio/video amplifier/receiver.

• **NOTE FOR ANALOG AUDIO:** The connection from Audio Out to the TV is optional. If you plan on using your DVD 101 alone, without turning on your complete system, this connection must be made; then you can turn up the TV's volume as needed. The analog audio jacks may also be connected to the standard analog left/right DVD or CD inputs on your receiver to processor if you wish to use the DVD 101 as the input for a multiroom system.

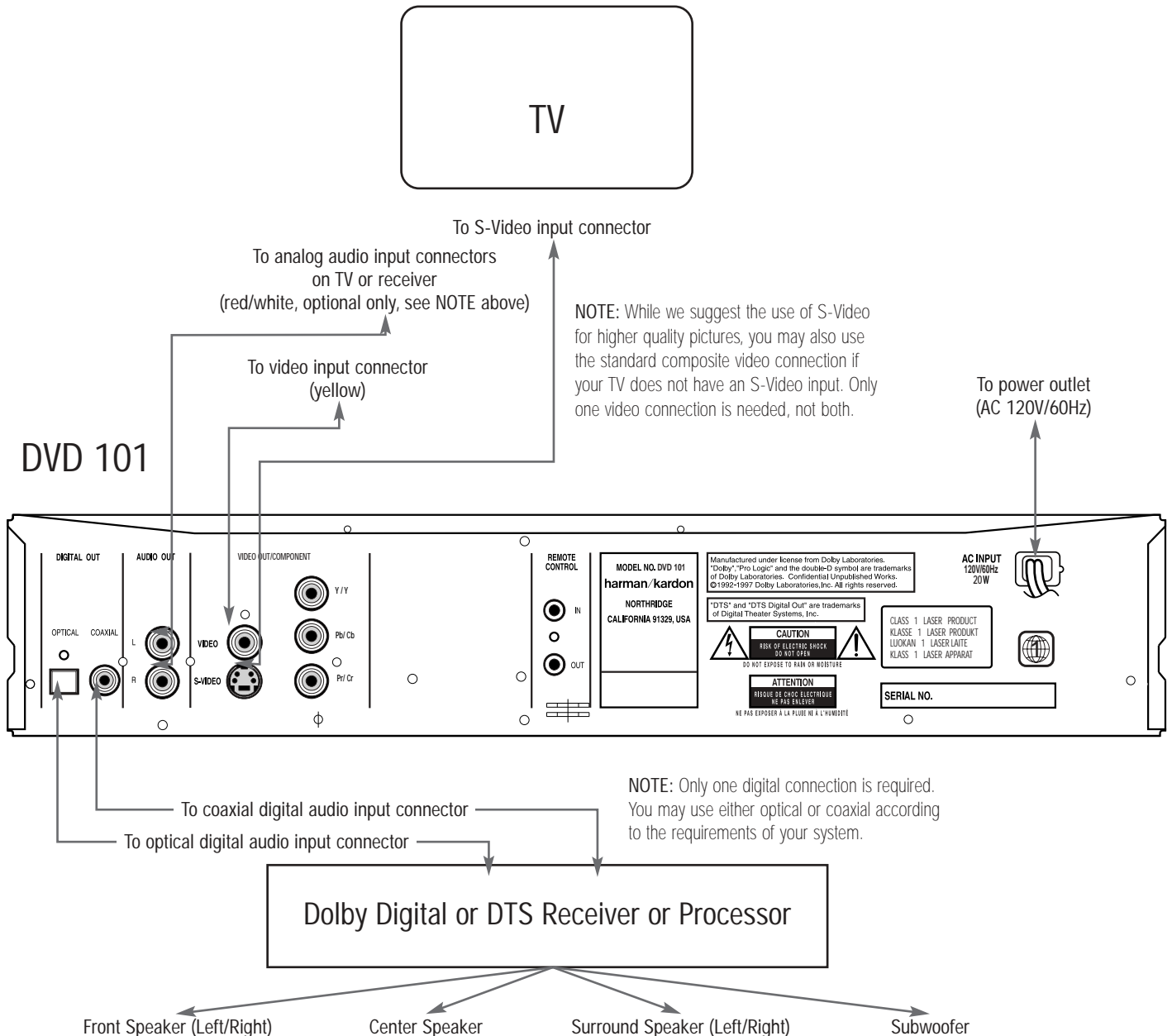

# SETUP AND CONNECTIONS

## Connecting to a TV or Monitor With Component Connectors – Component Video Connection

If the video display has component video inputs, connect the component video outputs on the DVD 101 to the corresponding input jacks on your television. If you are using a Progressive Scan television or projector,

you must also change the scan type in the DVD player's Video Setup menu from "Interlaced" to "Progressive." See page 17.

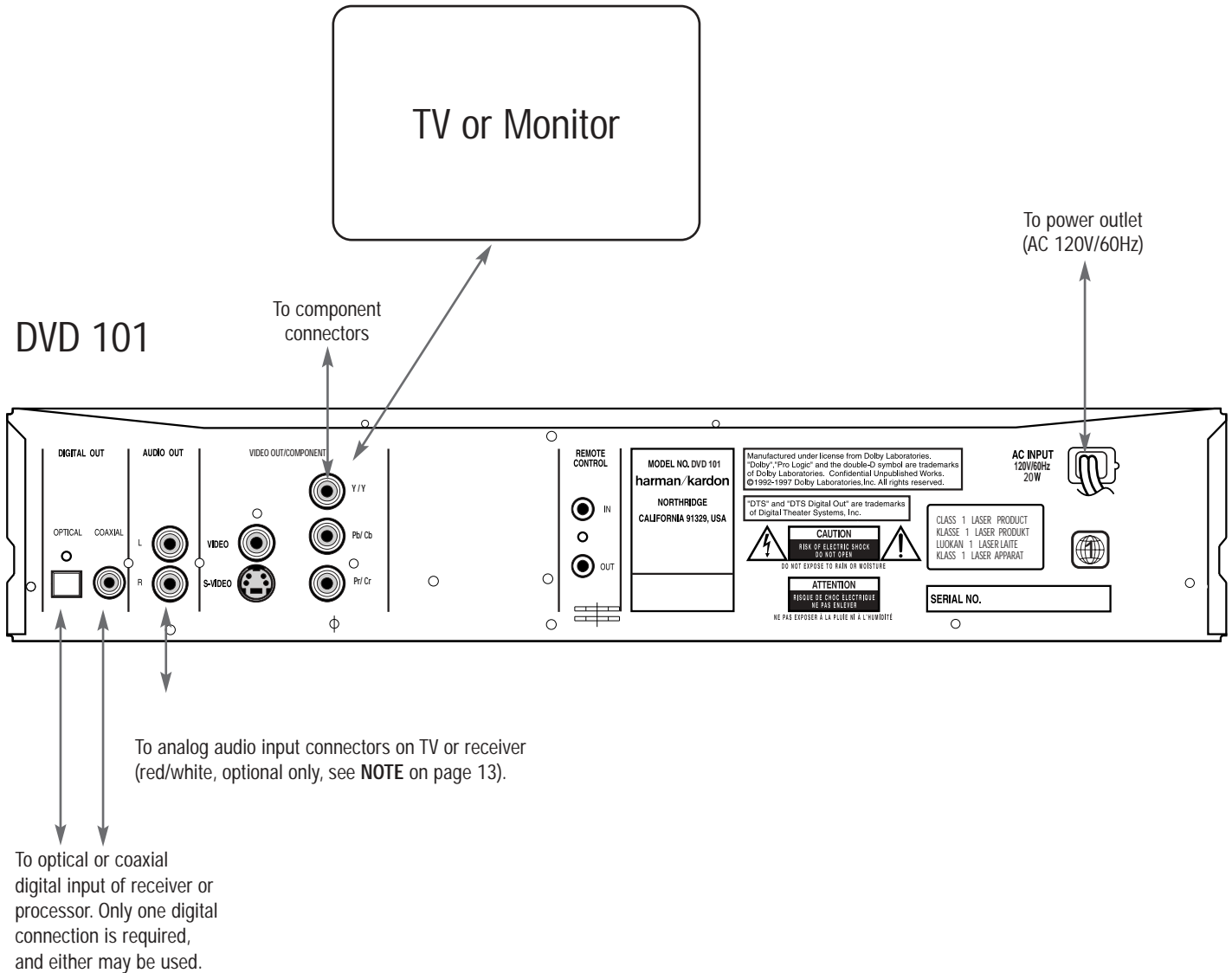

## Battery Installation

Insert the batteries supplied while observing the correct (+) and (-) polarities.

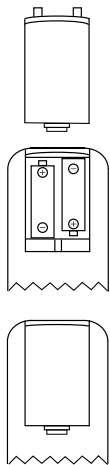

## Service Life of Batteries

- The batteries normally last for about one year, although this depends on how often, and for what operations, the remote control is used.
- If the remote control unit fails to work even when it is operated near the player, replace the batteries.
- Use fresh alkaline AA batteries.

### NOTES:

- Do not attempt to recharge, short-circuit, disassemble or heat batteries; do not throw them into fire.
- Do not drop, step on or otherwise batter the remote control unit. This may damage the parts or lead to a malfunction.
- Do not mix old and new batteries.
- Wipe away any leakage inside the remote control unit, and install new batteries.
- If leakage should come into contact with your skin, immediately wash it off thoroughly with water.
- Batteries contain chemical substances and we recommend that you dispose of them properly and in compliance with any local regulations.

## Remote Control Operation Range

Point the remote control unit from no more than about 20 feet from the remote control sensor and within about 60 degrees of the front of the unit.

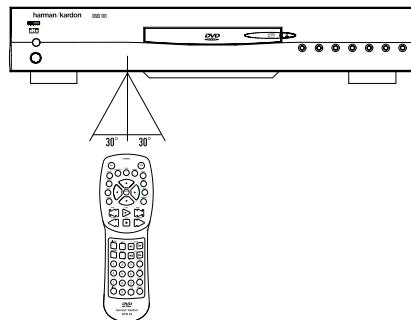

- The operating distance may vary according to the brightness of the room.

### NOTES:

- Do not point bright lights at the remote control sensor.
- Do not place objects between the remote control unit and the remote control sensor.
- Do not use this remote control unit while simultaneously operating the remote control unit of any other equipment.

# DIGITAL AUDIO CONNECTIONS

## Optical Digital Audio Connection Notes

- Remove the dust protection cap from the optical digital audio output and connect the cable firmly so that the configurations of both the cable and the connector match.
- Keep the dust protection cap and always reattach the cap when not using the connector.

## Audio Output From the Unit's Optical/Coaxial Digital Audio Output Connector

Disc:	Sound recording format:	Optical/coaxial digital audio output:
DVD	Dolby Digital	Dolby Digital bitstream (2-5.1ch) or PCM (2ch, 48kHz, 16-bit) <sup>††</sup>
	Linear PCM (48/96kHz, 16/20/24-bit)	Linear PCM (2ch) (48/96kHz, 16/20/24-bit)
	DTS	Bitstream or no output <sup>††</sup>
CD	Linear PCM	Linear PCM (44.1kHz sampling)

<sup>††</sup> Digital format must be selected as "Original" or "PCM" in Digital Output menu (see "Digital Output" section on page 18).

## For Your Reference:

- Dolby Digital is a digital sound compression technique developed by the Dolby Laboratories Licensing Corporation. Supporting 5.1-channel surround sound, as well as stereo (2-channel) sound, this technique enables a large quantity of sound data to be efficiently recorded on a disc.
- Linear PCM is a signal recording format used in CDs. While CDs are recorded in 44.1kHz/16-bit, DVDs are recorded in 48kHz/16-bit up to 96kHz/24-bit.
- If you have a Dolby Pro Logic Surround decoder connected to the DVD 101's analog audio out connectors, thanks to the "Downmix" function of the DVD 101 you will obtain the full benefit of Pro Logic from the same DVD movies that provide full 5.1-channel Dolby Digital soundtracks, as well as from titles encoded with Dolby Surround.
- The DVD 101 is designed to digitally output 96kHz PCM audio with a 96kHz sampling rate. The 96kHz indicator will light in the display. However, some 96kHz DVDs may include copy protection codes that do not permit digital output. For full 96kHz fidelity from these discs, use the analog outputs of the DVD 101. If your surround processor converter does not support 96kHz PCM audio, you must use the DVD 101's analog outputs for full 96kHz fidelity with these discs.
- When connecting an amplifier (with an optical/coaxial digital input) that does not contain a Dolby Digital or DTS decoder, be sure to select PCM as the initial setting in the Digital Output menu (see page 18). Otherwise, any attempt to play DVDs may cause such a high level of noise that it may be harmful to your ears and damage your speakers.
- CDs can be played as they would normally be played.

**NOTE:** Some first-generation DTS decoders that do not support DVD-DTS interface may not work properly with the DVD/CD player.

## Dolby Digital and DTS

Both Dolby Digital and DTS are audio formats used to record 5.1-channel audio signals onto the digital track of film. Both of these formats provide six separate channels: left, right, center, left rear, right rear, and common subwoofer.

Remember that Dolby Digital or DTS will only play 5.1-channel sound if you've connected the optical or coaxial output of the DVD 101 to a DTS or Dolby Digital receiver or decoder (see page 13) and if the disc was recorded in the Dolby Digital or DTS format.



## System Defaults

The final step of the installation is to establish the system's defaults. It is helpful to take a few minutes to familiarize yourself with these settings, as they may require change before the first use and later from time to time.

## Main Menu

The first step in checking or changing the system defaults is to access the Main menu. First, make certain that the DVD 101 is properly connected to a video display, and that power is connected. Turn the DVD 101 on by first pressing in the Main Power On/Off Switch **1** and then pressing the **Power On Button 2/1**. For this process, however, you do not need to load a disc into the unit.

During Stop, Pause or Play mode, if you press the **Setup Button 9** on the remote, the Main menu appears on the screen.



## Navigating Menus

The remote's **Navigation** (▲/▼/▶/◀) and **Enter Buttons 10** are used to navigate the menus and select specific settings. Use the **▲/▼ Buttons 10** to move the cursor to highlight the desired submenu, then press the **▶ Button 10** or **Enter Button 10** to enter the highlighted menu or choose the highlighted content. The current setting is highlighted.

If you wish to change this setting, use the **▲/▼ Buttons 10** to select a new setting and press the **Enter Button 10**. Press the **◀ Navigation Button 10** to return to the left submenu column. Press the **Play Button 4/17** or **Setup Button 9** to exit the Setup menu. Any new settings will be activated immediately, except for Aspect Ratio, which will be activated after the player exits the Setup menu.

After you press the **Setup Button 9** on the remote to enter the Main menu, three submenus are shown: Video, Audio and Player. You may press the **◀ Navigation Button 10** or select Exit with the **Navigation Buttons 10** and press the **Enter Button 10** at any time to leave the Main menu.

You may restore all original factory default settings at any time. When the player is in Standby, press and hold the **Clear Button 32** for six seconds. This will restore all default settings and any changes you have made will be lost.

## Video Menu

When you enter the Main menu, the Video submenu should be highlighted. If not, use the **▲/▼ Buttons 10** to highlight the Video menu, then press the **▶ Navigation Button 10** or **Enter Button 10** to access the Video menu. The left column shows the items in the Video menu. The right column shows the current setting for each item.



### Scan Type

Select SCAN TYPE with the **▲/▼ Navigation Buttons 10**, if it is not already selected; then press the **▶ Navigation Button 10** or **Enter Button 10** to access the Scan Type submenu. The right column displays the current setting (highlighted) and one option.



**IMPORTANT:** Before you select Progressive mode, you must make sure that your TV or projector can accept a progressive signal. When a standard video display is used you do not need to make any change in this menu, as the INTERLACED setting is the correct selection, even when component video is used. If the player is set to Progressive, but connected to a display device that cannot process a progressive signal, there will be nothing on the TV screen. If this happens, you can restore the player to Interlaced mode: Press the **Stop Button 19** on the remote and hold it down for more than three seconds. The player will revert to Interlaced mode and a picture should appear on the screen.

As a Progressive Scan DVD player, the DVD 101 can provide a high-resolution image in Progressive mode. If you have a compatible display device, you will experience significantly enhanced picture quality. The **Progressive Scan E** indicator in the front-panel display will light when Progressive Scan has been selected.

### Aspect Ratio

Select the Aspect Ratio menu with the **▲/▼ Buttons 10** if it is not already selected in the Video menu;

then press the **▶ Navigation Button 10** or **Enter Button 10** to access the Aspect Ratio submenu. The right column displays the current setting (highlighted) and two options. If needed, select a new setting. Press the **Enter Button 10** to confirm the new setting.



This menu selects the TV aspect ratio: conventional screen shape (4:3) or widescreen (16:9), according to your TV.

- **4:3 Letterbox:** Choose this setting if the DVD 101 is connected to a conventional (4:3) TV set and you would prefer to see movies without any parts being cut off. You will see the entire frame of the movie and DVDs recorded with normal 4:3 format will fill the entire screen. But movies in widescreen will occupy a smaller portion of the screen, with black bars at the top and bottom of the screen.
- **4:3 Pan Scan:** Choose this setting if the DVD 101 is connected to a conventional (4:3) TV set and you want widescreen movies to fill the entire screen. Note that this setting is effective only with a few widescreen DVDs recorded with the Pan and Scan mode. With those movies you won't see parts of the picture (particularly the right and left edges). Most discs produced in a widescreen format can't be cropped in this fashion, which means the black bars will appear at the top and bottom of the screen (letterbox format). Some widescreen DVDs, particularly anamorphic types (with full vertical-line resolution; see section "16:9" below), may be shown with original width but spread vertically. With these discs, the letterbox format must be selected. This setting is useful only with a few DVDs; with all others the letterbox format fits best.
- **16:9 Widescreen:** Choose this setting if your DVD player is connected to a widescreen TV, or to a conventional (4:3) TV changeable to widescreen (16:9) mode.

With this setup, discs recorded with 4:3 aspect ratio will appear as a boxed image in the center of a 16:9 widescreen TV, with black bars to the left and right of the image (not with 4:3 TVs changeable to 16:9 mode). True widescreen (anamorphic) DVDs (i.e., those shown spread vertically when the DVD 101 is set to "16:9" and your TV is set to "4:3") will be shown optimally with full vertical resolution. With some 4:3 TVs set to 16:9 format, discs with 4:3 format may be played compressed vertically. With those discs the TV must be set to 4:3 format.

# SYSTEM SETUP

## Audio Menu

In the Main menu, use the ▲/▼ **Navigation Buttons 10** to highlight the Audio menu; press the ► **Navigation Button 10** or **Enter Button 10** to access the Audio submenu. The left column shows the items in the Audio menu. The right column shows the current setting for each item.



### Dynamic Range

Select the Dynamic Range menu with the ▲/▼ **Buttons 10**, if it is not already highlighted; press the ► **Navigation Button 10** or **Enter Button 10** to access the Dynamic Range submenu.

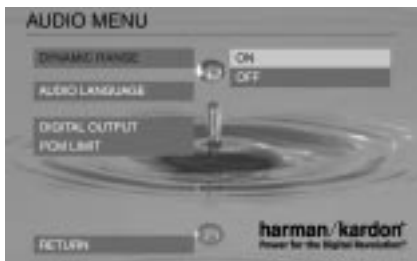

This setting enables Dolby Digital recordings to be played back with full dialogue intelligibility while reducing peak levels. This smooth level compression prevents abrupt loud transitions from disturbing others without reducing the impact of the digital source perceptibly.

To change the Dynamic Range setting, use the ▲/▼ **Navigation Buttons 10** to highlight DYNAMIC RANGE and then press the ► **Navigation Button 10**. Press the ▲/▼ **Navigation Buttons 10** to select ON or OFF, and then press the ◀ **Navigation Button 10** to enter the setting and return to the Audio menu.

**NOTE:** If selected, Dynamic Range compression is only active when a Dolby Digital signal is detected and only for the analog outputs.

### Audio Language

This step will define the default audio language (if the disc contains different language tracks). The option default will select the audio language originally encoded as the default language on the disc; most times this will be English. Choosing an audio language by pressing the **Audio Button 6** on the remote control (see page 25) will change this setting only temporarily.

Select AUDIO LANGUAGE with the ▲/▼ **Buttons 10**, if it is not already selected; press the ► **Navigation 10** or **Enter Button 10** to access the Audio Language submenu. The right column displays the current setting (highlighted) and the options.



If you are playing a disc with a language other than English, French, German, Italian or Spanish, press the ▼ **Navigation Button 10** until the word OTHER is highlighted. Next, press the ► **Navigation Button 10** and note the word OTHER will be replaced by four dashes. Using the chart on page 33, press the **Numeric Keys 29** to enter the number corresponding to the desired language. When the entry is complete, the menu screen will display the word OTHER, but the appropriate language will be selected as long as it is present on the disc being played.

### Digital Output

If your system includes 5.1 digital audio surround decoding (Dolby Digital and/or DTS), select ORIGINAL as the digital output. In that case all audio signals will be outputted with their original format. If your system only includes stereo and/or Dolby Pro Logic, select PCM. When PCM is selected you will not be able to use DTS soundtracks.



Select the Digital Output menu with the ▲/▼ **Navigation Buttons 10**, if it is not already selected; then press the ► **Navigation Button 10** or **Enter Button 10** to access the Digital Output submenu. The right column displays the current setting (highlighted) and one option.

### PCM Limit

Select the PCM Limit menu by pressing the ▲/▼ **Navigation Buttons 10** until PCM LIMIT is highlighted. At this menu you will be able select the sample rate for the digital output of the DVD 101 so that it is compatible with the circuitry in your receiver or processor. Before making this setting you may want to consult the Owner's Manual for the receiver or processor to determine which type of digital signals it is compatible with.

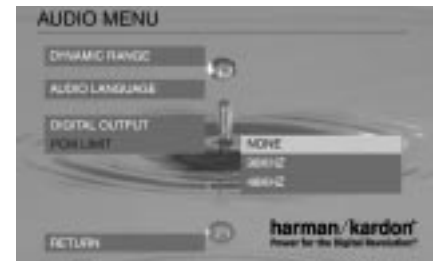

With that information in hand, select one of these options:

- If your receiver or processor is not capable of resolving digital inputs over 48kHz, or if you are uncertain of the capabilities of your receiver, select the **48kHz** option. In this case, the DVD 101 will down-sample any program material with higher sample rates so that it is compatible with your equipment.
- If your receiver or processor is capable of resolving digital inputs up to 96kHz, select the **96kHz** option. Many, but not all, receivers manufactured within the last two years are compatible with these signals.
- If your receiver or processor is capable of resolving all digital inputs, up to 192kHz, select **NONE**. In this case, all signals will be passed through at their native rate without down-sampling.

**NOTE:** If you play a disc that is recorded with a sample rate higher than 48kHz with either the **NONE** or **96kHz** setting when your receiver or processor is not compatible with those types of signals you will not hear any output even though the disc is playing properly. In that case, change the setting to 48kHz to complete compatibility with all receivers and processors, particularly older ones.

When all adjustments to the Audio menu are done, press the ▼ **Navigation Button 10** until RETURN is highlighted and then press the **Enter Button 10** or simply press the ◀ **Navigation Button 10**.

## Player Setup Menu

The Player Setup menu contains a number of setup parameters that are normally adjusted only once to establish basic operational settings for the DVD 101.

From the Main menu, use the ▲/▼ **Navigation Buttons** **10** to select the Player menu, then press the ► **Navigation Button** **10** or **Enter Button** **10** to access the Player menu. The left column shows the items in the menu. The right column shows the current setting of each item.

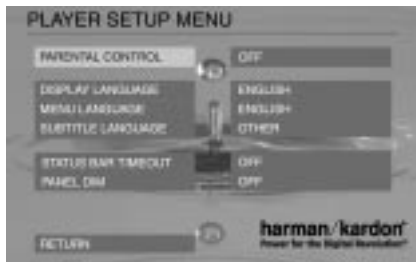

### Parental Control

The DVD 101's Password System is used to control viewing of restricted programs and the capability to change the password itself and the rating. The DVD 101 is shipped with "8888" as the default password and with the parental control settings off. The following instructions will show how to change the password and lock the settings.

**NOTE:** The DVD must be specifically encoded with rating information for Parental Control to work.

### The Rating Levels

The five MPAA rating symbols are "G" (General, Level 2), "PG" (Parental Guidance, Level 4), "PG13" (Parental Guidance and 13 years old, Level 4), "R" (Restricted, Level 6) and "NC 17" (from 17 years old, Level 7). The DVD 101 will accommodate a total of eight rating steps, as set by the DVD creators. These additional steps allow for more critical control of program playback for all audiences.

Level 8: All DVDs can be played.

Levels 7 to 2: DVDs for general audiences/children can be played.

Level 1: DVDs for children can be played, DVDs for adults/general audiences are prohibited.

### Password

If you change the password from the factory default setting, please remember to write the new password in a safe place. You cannot access rated discs or rating/password menus or change or clear the password (see below) without entering the correct password.

If you forget your password, you can reset the DVD 101 to the factory default password (8888) when the player is in Standby by pressing and holding the **Clear Button** **32** for six seconds. **NOTE:** This will restore all menu settings to the factory default settings. Any changes you have made will be lost.

### Enter Password and Setting Level

For disabling the playback of rated DVDs, a password consisting of four digits must be entered.

Select PARENTAL CONTROL in the Player Setup menu, then press the ► **Navigation Button** **10** or **Enter Button** **10** to access the Parental Control submenu. PASSWORD appears in the right column. Enter the password (the initial password is 8888).



If the password is correct, the following display will appear in the menu:

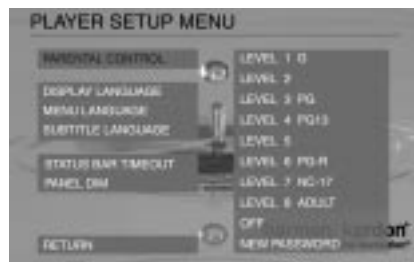

When the ratings list appears press the ▲/▼ **Navigation Buttons** **10** to select the desired ratings control level. **REMEMBER:** The lower the number, the higher the restriction. When the level you prefer is highlighted, press the **Enter Button** **10** to activate it.

### Change Password

After the password was entered or the parental control level was set, use the ▼ **Navigation Button** **10** to make sure the cursor is pointing to NEW PASSWORD. Enter the new password. The display will change to CONFIRM, requesting that you repeat the new password to confirm that it is correct. If you have correctly entered the new password twice, the display will confirm the change with "OK." Press the ◀ **Navigation Button** **10** to exit the level/password submenu.

When all desired adjustments to the Parental Control and Password system have been made, press the **Enter Button** **10** to record the settings in the unit's memory and return to the Player Setup menu. Press the ▼ **Navigation Button** **10** to continue with the setup, or press the ◀ **Navigation Button** **10** to return to the Main menu.

### Display Language

The Display Language menu allows you to select the language in which the DVD 101's control menus and messages appear. If you do not need to change the setting from the default selection of English, press the ▼ **Navigation Button** **10** to move to the next menu item. If you do wish to change the menu language to a choice other than English, make certain that DISPLAY LANGUAGE is highlighted and then press the ► **Navigation Button** **10**. The available options will then appear on the right side of the screen.



Use the ▲/▼ **Navigation Buttons** **10** to select the desired option. When you have made your selection, press the ◀ **Navigation Button** **10** to continue the Player Setup options.

# SYSTEM SETUP

## Menu Language

The Menu Language menu allows you to select the language that will be used to display the menus generated by the DVD that is being played. Note that although this menu permits you to select a language, in order for that language to appear it must be present on the disc. Before making a change to this menu, consult the DVD jacket for information on the menu languages available for any particular disc. In addition, if your menu choice is English, no change to the default setting is needed, in which case you may press the **Navigation Button 10** to proceed to the next setting.

To change the setting, make certain that the MENU LANGUAGE line is highlighted and press the **Navigation Button 10**. The right side of the screen will then display the available options and the current Menu Language setting will be highlighted.



Press the **Navigation Buttons 10** to select the desired choice for the on-screen menus provided by the DVD. In the event the disc provides language options other than English, French, German, Italian or Spanish, select the OTHER option, and note that four dashes will appear. Consult the chart on page 33 to match the menu language options available to the code number for that language. Press the **Numeric Keys 29** to enter the language code number and note that the menu will return to OTHER when the entry is complete.

When the selection process is complete, press the **Navigation Button 10** to continue with the selection options for other features.

## Subtitle Language

The Subtitle Language menu allows you to select the language that will be used to display the subtitles that accompany the DVD's audio track. Note that although this menu permits you to select a language, in order for that language to appear it must be present on the disc. Before making a change to this menu, consult the DVD jacket for information on the subtitle languages available for any particular disc. If your menu choice is English, no change to the default setting is needed, in which case you may press the **Navigation Button 10** to proceed to the next setting.

To change the setting, make certain that the SUBTITLE LANGUAGE line is highlighted and press the

**Navigation Button 10**. The right side of the screen will then display the available options and the current Subtitle Language setting will be highlighted.

With this setting you define your preferred subtitle language (if the disc contains different subtitles). You may also change the subtitle language at any time when a disc is playing by pressing the **Subtitle Button 3** on the remote during disc playback. Changes made with the Subtitle Button are temporary and will only be effective during the playback of a specific disc, while the changes made in this menu will become the unit's default setting.

This setting can turn subtitles on or off. If set to OFF, subtitles will not be displayed automatically. The **Subtitle Button 3** on the remote control can be used to select and change subtitles during playback.

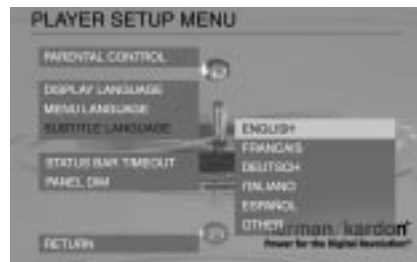

Press the **Navigation Buttons 10** to select the desired choice for the subtitle. In the event the disc provides subtitle language options other than English, French, German, Italian or Spanish, select the OTHER option, and note that four dashes will appear. Consult the chart on page 33 to match the menu language options available to the code number for that language. Press the **Numeric Keys 29** to enter the language code number and note that the menu will return to OTHER when the entry is complete.

When the selection process is complete, press the **Navigation Button 10** to continue with the selection options for other features.

## Status Bar Time Out

This setting allows you to select the length of time the Status Bar (On-Screen Banner Display) remains on the screen when it is called up during DVD playback. To make a change to this setting from the Player Setup Menu, press the **Navigation Button 10** until STATUS BAR TIMEOUT is highlighted and press the **Navigation Button 10**.



The current setting and available choices will then appear on the screen. When set to OFF, the Status Bar will remain on-screen when selected, until the **Status Button 14** or **Clear Button 32** is pressed on the remote control. If set to 5 or 20 seconds, the Status Bar will disappear after that number of seconds. However, during CD playback, the Status Bar will always remain on-screen unless the **Clear Button 32** or **Status Button 14** is pressed.

## Panel Dim

This setting allows you to select the length of time the front-panel display remains illuminated during disc playback. To make a change to this setting from the Player Setup menu, press the **Navigation Button 10** until PANEL DIM is highlighted and then press the **Navigation Button 10**. The current setting and available choices will appear on the screen.



With the PANEL DIM menu on the screen, press the **Navigation Buttons 10** to select one of the following options. Select OFF to turn off the dimmer function. This is the default setting, and it turns off the dimmer so that the front-panel display remains lit at all times. To have the front-panel display turn off after a preset period of time, select the 5- or 20-second options. When one of these two selections is made, the main display readout will dim after the desired time period, but the **Disc-Type Indicator A** and the **Playback Mode Indicator B** will remain lit to remind you that the unit is operating.

**NOTE:** If the front-panel display is set to turn off using this menu, the display may be recalled at any time during playback by pressing any button on the remote.

After the desired setting is made, press the **Navigation Button 10** to return to the Player Setup menu. You may now make any other desired configuration settings, or press the **Navigation Button 10** to return to the Main menu.

When all desired setup and configuration entries have been made, press the **Navigation Button 10** with the Main menu on the screen so that EXIT is highlighted and press the **Enter Button 10**. The unit will return to normal operation and you are ready to enjoy the finest in DVD or CD playback!

DVD is one of the highest quality sources ever made available for in-home playback of prerecorded pictures and sound. In order to make certain that your home theater system is fully optimized to take advantage of DVD's superb picture quality, the DVD 101 offers a built-in video test signal that makes it easy to calibrate your TV or video display for proper playback.

## Test Screen

To utilize the built-in test screen, press the **Test Button** **7** on the remote. If a disc is playing when the button is pressed, the playback will be paused in the Resume mode so that you may return to the same spot in the program when your adjustments are complete. When the button is pressed the test screen will appear, allowing the following adjustments to be made:

- The proper color intensity setting on your TV.
- Proper color adjustments using the color bars, which should be (left to right) black, white, yellow, cyan (turquoise), green, magenta, red, blue, black.
- The proper color transition, seen as sharp separation of the bars.
- The performance of the color filter in your TV (with "Video" signals); bar edges should show no vertical crawling dots.

With the gray scale and the black/white fields below the color bars, the brightness and contrast of your screen can be adjusted.

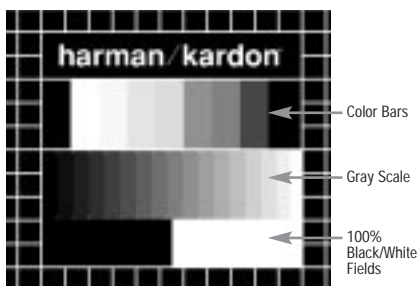

## TV Picture Adjustment With Test Screen

### Brightness Adjustment:

1. Turn down the color control on your TV until the color bars are visible in black and white.
2. Adjust the contrast to the lowest level where you still can see all bars within the gray scale in the test picture separately and clearly.
3. Adjust the brightness so that the bars in the gray scale are all visible. The bar furthest to the left has to be as black as possible rather than gray but the next gradation must clearly be distinct from it. All the bars in the gray scale should be gradually and evenly changing from black to white, going from left to right.

### Contrast Adjustment:

1. Adjust the contrast on your TV until you see a bright white bar in the lower right corner of the screen and a deep-dark-black bar at the left. The optimal contrast setting will depend on your preference and the surrounding light in the TV room.
2. If the brightness of the white bar no longer increases when the contrast is turned up or the borders of the white "harman/kardon" letters on top bloom (overlight) into the black areas (drastically decreasing the sharpness of the type), the contrast has been turned up too much. Reduce the contrast until these effects disappear and the video still looks realistic.
3. If you are watching TV with customary surrounding daylight, adjust the contrast so that a normal video picture has about the same look as the surroundings in your room. That way the eye is relaxed when watching the TV picture. This contrast setting may be reduced when the surrounding light is dimmed, thereby usually improving the sharpness of a video significantly.
4. The gray scale in the middle line needs to have the same clear difference between each bar as before the contrast adjustment. If not, go back to "Brightness Adjustment" and repeat Step 3 and then "Contrast Adjustment," making only minor adjustments each time for optimization.

## Color Adjustment

1. When the brightness and contrast are set optimally, turn up the color control to the level of your preference. Adjust to the level where the colors look strong but still natural, not overdone. If the color level is too high, depending on the TV, some of the bars will seem wider or the color intensity will not increase while the control is turned up. Then the color control must be reduced again. Ultimately, you also should test the color intensity with a video – e.g., pictures of natural faces, flowers, fruit and vegetables and other common natural articles for an optimal setting of the color intensity.
2. Use the large white bar below the gray scale to tweak the warmth of the picture. Every viewer has a preference as to how the glow of the picture should be. Some prefer a little colder picture, some a warmer glow. The Tint function on your TV and the white bar can be used to control this. Adjust the Tint to the level where you feel the white color has the tone you prefer.

# PLAYBACK BASICS FOR ALL FORMATS

## Loading Discs

To load discs in the DVD 101, first turn the DVD 101 on by pressing in the **Main Power On/Off Switch 1** and then pressing the **Power On Button 2/1**. Note that the LED indicator surrounding the **Power On Button 2** will turn amber when the power is first applied by pressing in the **Main Power On/Off Switch 1**. It will turn green when the **Power On Button 2** is pressed. Once the **Main Power On/Off Switch 1** is turned on, it is normally left in that position unless you wish to turn the unit completely off so that the remote control will not be able to turn the player on.

Next, press the **Eject Button 8/3** until the disc tray opens.

Hold the disc by the edge, and gently place it into the disc drawer, making certain that the disc is properly seated in the tray's insert. If the disc is not correctly centered you may damage both the disc and the player when the drawer closes. When loading discs, please note the following:

- The DVD 101 will play discs with the following logos, as well as most DVD-RW or DVD+RW discs. DO NOT attempt to play another type of disc.



## MP3

- The DVD 101 will only play discs in the NTSC video format. It will not play discs for other standards such as PAL or SECAM.
- Playback capability for CD-RW, DVD-RW or DVD+RW discs will vary according to the quality of the disc. On some occasions it is possible that these discs may not play on the DVD 101. This does not indicate any problem with the DVD 101.
- The DVD 101 will only play discs that are coded for Region 1 or discs that are open to being played in all regions. Discs that contain a Region Code of 2, 3, 4, 5 or 6 (as noted by a number inside a world map logo on the disc's cover jacket or case) will not play.
- Both 5-inch (12cm) and 3-inch (8cm) discs may be used.

- When loading CD audio discs, load the discs with the label side up.
- When loading DVD discs with printed labels, load them label side up.
- Some DVD discs are double-sided. The title information for these will be printed on the inner ring of the disc, very close to the center hole. The title for the side you wish to play should be facing up.

Once a disc is properly loaded, press the **Eject Button 8/3** to close the disc drawer. After the drawer closes, you will see a brief indication of **Reading** in both the Information Display and in the on-screen display to alert you to the fact that the unit is determining the type of disc (DVD, CD, VCD or MP3) and is reading the data for track, chapter, title and other information about the disc.

Once the disc's data has been read, the type of disc will be displayed by the **Disc-Type Indicator A** and the disc will automatically begin playing. The disc's track timing information and other relevant data will appear in the information display. For CD discs only, a Status Bar (On-Screen Banner Display) will automatically appear in the on-screen display. To view this display for DVD discs, press the **Status Button 14**.

Basic playback with the DVD 101 involves functions similar to those you may be familiar with for conventional CD players or changers:

- Turn the DVD 101 on by first pressing in the **Main Power On/Off Switch 1** and then pressing the **Power On Button 2/1**.
- If a disc is already in the drawer when the unit is turned on, it will begin playing. If the disc was stopped using the Resume function, playback will begin from the point where it was stopped. If the disc was stopped by pressing the **Stop Button 6/19** twice, the disc will begin playing from its beginning.
- After loading a disc, press the **Eject Button 8/3** to close the drawer and begin play.

Playback Features for DVD and CD Discs:

- To momentarily pause playback and freeze the current picture frame on a DVD, press the **Pause Button 5/13**. To resume playback after pressing the Pause button, press the **Play Button 4/17**.
- To move forward or backward through the tracks on a CD or the chapters on a DVD, press the **Skip Forward/Reverse Buttons 7/8** on the front panel or the **Previous/Next Buttons 15/16** on the remote.

- To move forward or backward through the DVD or CD disc being played at fast speed, press the **Search Forward/Reverse Buttons 18/20**. Once one of these buttons is pressed, the fast search will continue until the **Play Button 4/17** is pressed. Note that the fast-play speeds are different for CD discs and DVDs.

For DVD playback, there are four fast-play speeds. Each press of the **Search Forward/Reverse Buttons 18/20** will cycle to the next speed in the following order: 2x, 4x, 8x, 16x.

Note that there will be no audio playback during fast-forward or reverse-play of DVD discs. This is normal for DVD, as A/V receivers and surround processors cannot process the digital audio streams during fast-play modes; audio will be heard during fast-play of conventional CDs.

For CD playback, there are two fast-play speeds. Each press of the **Search Forward/Reverse Buttons 18/20** will cycle to the next speed in the following order: 5x, 15x.

**NOTE:** Fast Search is not available when MP3 discs are playing.

When playing a DVD disc, you may move forward or backward through the program being played in one of four speeds by pressing the **Slow Play Buttons 22/24** on the remote. Each press of the buttons will move to the next speed in the following order: 1/2x, 1/4x, 1/8x, 1/16x.

Note that there is no audio playback during slow-forward or -reverse play of DVD discs. This is normal for DVD, as A/V receivers and surround processors cannot process the digital audio streams during slow modes. Slow-play is not available for CD discs.

- When a camera icon appears on the screen, and the **Angle Indicator M** flashes, this is your indication that there is multiple-angle information on the disc being played. To change the angle, press the **Angle Button 5** until the desired angle view appears. An on-screen banner message will appear to indicate the angle view in use.

To illuminate the buttons on the remote control so that they may be seen in low-light conditions, press the **Light Button 34**.

## Using a DVD's Menu

One of the unique features of the DVD system is that it offers a producer the opportunity to include a wide range of features on a disc, including multiple-language tracks; subtitles in a variety of languages; special information such as movie trailers and cast information; as well as other custom-tailored information. In addition, producers may divide a movie or program into chapters that allow for quick access to specific parts of the program. These chapters may be accompanied by thumbnail pictures of a scene from the specific chapter to help you select the desired spot on the disc.

When a disc is playing, press the **Menu Button** **12** to pause the playback and display the disc's menu. As there are no hard rules about style and contents for DVD menus, the way they appear on the screen and the information they contain will vary from one disc to another. However, the following general rules apply to most menus:

- The first menu that appears is the Main Menu, and you may move through the options with the **▲/▼/◀/▶ Navigation Buttons** **10**, as the disc's programming allows. The option selected will typically be highlighted in a certain color or inside an outline box.
- To select a highlighted option, which may either play a portion of the disc or move to a submenu, press the **Enter Button** **10** or **Play Button** **4/17**.
- On some discs, when you select the DVD menu during the playback of a movie, the disc will return to the point in the program where the menu was selected by offering a "Play Movie" option. Press the **Enter Button** **10** or **Play Button** **4/17** to resume play. However, not all discs offer this feature, and selecting the menu while playing a movie may mean that you will either have to go back to the beginning of the program or the start of a chapter. This feature is out of the control of the DVD 101, as it is set by the disc's internal programming.

## Important Notes on DVD Playback

The DVD 101 is capable of all the features and options covered by the DVD standards. However, it is up to the producer of a DVD disc to decide which of those features and functions are available on any given disc. For that reason, not all discs will function identically, and some discs will not have many of the features of the DVD system. For example, most current DVD discs do not take advantage of the multiple-angle feature. When you press a button and the player displays the "Feature Prohibited" icon "⊗", this is an indication that the disc has not been programmed for that feature.

In addition, it is common for the producers of DVD discs to block the use of certain functions during only some parts of a disc. For example, many discs prohibit the use of fast-play buttons or prohibit access to the Chapter Menu display during the playback of copyright notices, studio logos, movie credits or trailers. The appearance of the "Feature Prohibited" icon "⊗", or the inability of certain features to operate when the disc itself has prohibited them, does not indicate a problem with the DVD 101, as these features are outside of the unit's control.

## Zoom Feature

The DVD 101's advanced digital video processing circuits include a Zoom feature that allows you to enlarge the image for closer examination of a particular part of the picture. Four steps of enlargement are available, and you may move the picture around the screen while it is enlarged to locate a specific area.

- To use the Zoom feature, press the **Zoom Button** **23** while a disc is playing or paused. Each press of the button will increase the zoom-in effect. When you have zoomed through all four steps, the picture will return to normal size.
- Some discs are created in a way that prevents the Zoom feature from operating. In addition, the Zoom feature will not operate on disc menus and may not operate on subtitles.

## Playback Resume Feature

The DVD 101 offers a "Resume" feature that is different from the conventional "STOP" function you may be used to on CD players. When the **Stop Button** **6/19** is pressed once, the disc will stop and an on-screen RESUME indication will appear on the video screen. While the Resume feature is active, the disc's position is entered into the unit's memory so that when the **Play Button** **4/17** is pressed to resume playback, the program will continue at the point where it was when the **Stop Button** **6/19** was pressed.

To completely stop playback, press the **Stop Button** **6/19** twice.

# PLAYING DVDs

## Using the On-Screen Banner Display

The On-Screen Banner Display Menu, or "Status," contains many playback features. To see the On-Screen Banner Display, press the **Status Button 14** on the remote while a disc is playing. Use the **▲/▼/◀/▶ Navigation Buttons 10** on the remote to move through the different features in the On-Screen Banner Display. Each feature is illustrated with an icon.

Use the **▲/▼/◀/▶ Navigation Buttons 10** on the remote to highlight an icon in the banner. When an icon is highlighted, press the **Enter Button 10** on the remote to select it (not needed with TITLE and CHAPTER) and to change it (see below).

**NOTE:** When a CD or VCD is played, a different On-Screen Banner Display will appear; see pages 28 and 32.

TITLE	AUDIO	ANGLE	TIME			
T	C	AUDIO	SUBTITLE	A	PS	T-ELAPSED
0	0	English	OFF	1	0	00:00:22
CHAPTER		SUBTITLE		PROGRESSIVE SCAN MODE		

**Title:** The number shown indicates the number of the title that is currently playing.

**Chapter:** The number shown indicates the number of the chapter that is currently playing.

**Audio:** The current audio language or language and format (e.g., Dolby Digital) is shown.

**Subtitle:** The current subtitle language is shown. OFF indicates that no subtitles are playing.

**Angle:** The current multiple angle is shown.

**Progressive Scan Mode:** The current progressive scan mode is shown.

**Time:** This section of the display offers a choice of time display modes relating to the disc being played. When this section is highlighted, press the **▲/▼ Navigation Buttons 10** to select from the following choices:

- T-ELAPSED: Indicates the time elapsed in the current track. In cases where a disc only has one track, this will be the same as the time elapsed on the disc.
- T-REMAIN: Indicates the time remaining in the current track. In cases where a disc only has one track, this will be the same as the time remaining in the current track.
- D-REMAIN: Indicates the total time remaining on the disc.
- D-ELAPSED: Indicates the total elapsed time on the disc. If you press the **Enter Button 10**, the player displays SET TIME. You can enter the starting time from which you wish the disc to play, then press

the **Enter Button 10** or **Play Button 17** to start playback from the selected point on the disc.

Remember that the invalid symbol (Ø) appears on the screen when you press a button that doesn't have any function. To make the Banner Display disappear from the screen, press the **Status Button 14** or the **Clear Button 32** on the remote control.

## Selecting a Title

Some discs contain more than one title. For example, intros and "making of" often are divided into several titles. You can press the **Prog Button 30** on the remote to view the number of titles recorded on a disc (in parentheses below the "Title" icon) after a disc was read and the player is in Stop or Resume mode. To return to the normal display, press the **Prog Button 30** again.

To select a specific title, use the TITLE section in the Banner Display:

1. During Disc Stop, Resume or Play mode, press the **Status Button 14** on the remote.
2. Press the appropriate **▲/▼/◀/▶ Navigation Buttons 10** on the remote to highlight the Title icon (when the Banner Display appears, just this icon will be highlighted).
3. Use the **▲/▼ Navigation Buttons 10** to select a title number, or use the **Numeric Keys 29** on the remote to enter the title number. The selected title will be played at once after the last title number was entered.

**NOTE:** Some discs have only one title.

## Selecting a Chapter

Because DVDs use digital technology, a title can be divided into individual chapters (similar to tracks on a CD). You can press the **Prog Button 30** on the remote to see the numbers of chapters of each individual title on a disc (below the "Chapter" icon) after the disc has been read and the player is in Stop or Resume mode. To escape from the program menu, move the cursor to the DONE box and press the **Enter Button 10**.

You can skip to a specific chapter by using the CHAPTER section in the Banner Display:

1. While a disc is in Stop, Resume or Play mode, press the **Status Button 14** on the remote.
2. Press the **▶** or **◀ Navigation Buttons 10** on the remote until the Chapter icon is highlighted.
3. Use the **▲/▼ Navigation Buttons 10** to select a chapter number, or use the **Numeric Keys 29** on the remote to enter the chapter number. The selected chapter will be played at once after the last chapter number is entered.

## Selecting the Audio Track

Many discs contain more than one audio track. In some cases multiple languages may be present, in other case you will find the same language, but in different audio formats (e.g., Dolby Digital or DTS) or with commentary from the director or Descriptive Video Service. To change the language when the AUDIO section is highlighted, press the **▲/▼ Navigation Buttons 10** to select from the choices available. Not all discs offer multiple audio tracks, and the selection will vary from disc to disc. Consult the disc's jacket for information on the available audio tracks. You may also select the audio track directly from the remote control as shown on the next page.

## Selecting the Subtitle Language

Many discs contain one or more subtitles. To change the language when the SUBTITLE section is highlighted, press the **▲/▼ Navigation Buttons 10** to select from the choices available. Not all discs offer subtitles, and the selection will vary from disc to disc. Consult the disc's jacket for information on the available subtitles. You may also select the subtitle language directly from the remote control as shown on the next page.

## Selecting an Angle

Some discs contain multiple angle information. When a disc with multiple angles is playing you may change the angle pressing the **◀/▶ Navigation Buttons 10** until the A section of the banner menu is highlighted. Then press the **▲/▼ Navigation Buttons 10** to select from the available choices. You may also select the multiple view angle directly from the remote control as shown on the next page.

## Selecting the Progressive Scan Format

When the DVD 101 is configured for progressive scan playback the unit automatically selects the type of progressive scan reconstruction that produces the best picture. However, when certain processing techniques are used during the transfer of a film to video or in the creation of the disc it is possible that artifacts in the disc may "fool" the processor into using an algorithm that produces unwanted screen artifacts. In these cases, manually selecting the progressive scan mode may improve the progressive scan output. To manually select a mode, press the **◀/▶ Navigation Buttons 10** until PS is highlighted. Then press the **▲/▼ Navigation Buttons 10** to cycle through the four available modes.



## Changing the Audio Track

Please remember you can only access the various Audio Track, Subtitle, Angle and Repeat Displays when playing a disc. Also, each Banner Display feature is only available if the disc was created with that particular feature (i.e., if you select the Subtitle icon, you won't be able to change the subtitle language unless the author of the disc created the disc with subtitles).

DVDs may contain a variety of audio tracks, including foreign languages, special commentaries, descriptive video for the sight-impaired, and various digital formats. In normal play, the unit will always look for the default setting for the audio track, but you may change the audio track at any time using the **Audio Button 6** on the remote control.

While playing a disc, press the **Audio Button 6** on the remote control once to see the Audio Display with the current audio language and format. Press repeatedly to select other languages and/or audio formats.



AUDIO : English  
Dolby Digital

### NOTES:

- The audio feature only works if the disc was created with multiple audio tracks.
- Some DVDs do not allow direct selection of audio during playback. Instead, you must use the audio setup section of the disc menu.
- When you choose an audio language with the **Audio Button 6** on the remote control, you only override the audio language setting in the DVD player's Main menu (Audio menu within Setup menu) temporarily.

## Changing the Subtitle Language

DVDs may contain a variety of subtitles. In normal play, the unit will always look for the default setting for the subtitle language, but you may temporarily change that language at any time using the **Subtitle Button 3** on the remote.

While playing a disc, press the **Subtitle Button 3** on the remote control once to see the Subtitle display with the current subtitle language. Press repeatedly to select other subtitle languages.



SUBTITLE : English

**NOTE:** The subtitle feature only works if the disc was created with subtitles.

## Changing the Camera Angle

A special feature of the DVD format is its capability of showing more than one view, or camera angle, of the same scene. This feature enables you to become the director, selecting the view of a scene that you wish. However, this feature does not appear on many discs and, when it does appear, it will typically be for only certain scenes and not for the entire disc's program.

To see whether a disc contains multiple angles, check the disc's cover or jacket. When the DVD's title or chapter played currently does contain scenes with multiple angles, the multi-angle symbol in the upper right corner of the front-panel display will flash. The multi-angle feature is only available when this symbol is flashing.

When the multi-angle symbol flashes, you can press the **Angle Button 5** on the remote control. The Angle Display will appear with the camera angle currently being viewed and the total number of angles on the disc.

Press the **Angle Button 5** again to change the camera angle. The number of angles available may differ from one disc to another.



ANGLE : 1/4

## Repeat Play

The DVD 101 offers three repeat functions that allow you to take advantage of the capacity of the unit for unattended playback:

- **Repeat Title:** For DVD discs only, this mode repeats the title currently being played until the disc is manually stopped; in the front-panel display **REPEAT H** and **ALL H** will light up, and REPEAT TITLE will appear on-screen.
- **Repeat Chapter:** Repeats the DVD chapter currently being played until the disc is manually stopped; in the front-panel display **REPEAT H** and **1 H** will light up, and REPEAT CHAPTER will appear on-screen.
- **Repeat A-B:** Repeats any selected portion of the disc until the disc is manually stopped.

To select any Repeat mode:

1. While a disc is playing, press the **Repeat Button 33** on the remote; the Repeat Display appears.



REPEAT CHAPTER

2. Access the Repeat modes and their appropriate menus in the following order by pressing the **Repeat Button 33** on the remote repeatedly until the desired function is displayed: REPEAT TITLE → REPEAT CHAPTER → REPEAT OFF.
  3. To make the menu disappear from the screen, press the **Clear Button 32** on the remote or wait a few seconds.
- To stop any Repeat Play function and continue normal play, press the **Repeat Button 33** until the Repeat Off menu appears in the on-screen display and all Repeat indicators in the Front-Panel Information Display go out.
  - Repeat Play may be stopped by pressing the **Stop Button 6 19** twice.

# PLAYING DVDs

## A-B Repeat Play

The Repeat A-B function allows you to select any portion of a DVD and have it repeat continually until the unit is manually stopped.

To initiate a Repeat A-B playback sequence, follow these steps while a disc is playing:

1. While a disc is playing, press the **A-B Button** **35** on the remote when you want to choose a scene as the beginning point; the Repeat A- Display appears.



2. Press the **A-B Button** **35** again to choose a scene as the end point. Repeat A-B setting is done; A-B section will be played continuously.
3. Press the **A-B Button** **35** on the remote again to cancel Repeat A-B mode.
4. To make the menu disappear from the screen, press the **Clear Button** **32** on the remote or wait a few seconds.

**NOTE:** The A-B Repeat range may cover several titles or chapters as long as the DVD's control system does not force the unit to return to any DVD menu in between.

## Zoom Playback

The DVD 101's advanced digital video processing circuits include a Zoom feature that allows you to enlarge the image for closer examination of the picture.

Four steps of enlargement are available. To zoom in on the picture, press the **Zoom Button** **23** while a disc is playing or paused. Press again to step through the four magnification steps or to cycle back to normal picture size.

Some discs do not allow the use of the Zoom feature. In addition, Zoom may not operate on some disc menus and on subtitles.

## Information Menus

The DVD 101 has the capability to give you an on-screen overview about various information on the current disc or all important player settings made, with the press of one button and without having to stop the playback mode.

While the disc is playing, press the **Info Button** **11** on the remote once for detailed information on the disc playing such as Disc Type and Audio Bit Rate, Movie Aspect Ratio, Audio Resolution and others.



• DISC INFORMATION •	
Disc Type:	DVD-Video
Movie Aspect:	4 : 3
Video Bit Rate:	0 kb/s
Movie Scan Type:	Progressive
Audio Resolution:	16 bits 48kHz
Audio Bit Rate:	0 kb/s
Titles:	43
Angles:	3

Press the **Info Button** **11** again to view a display of the current player settings.

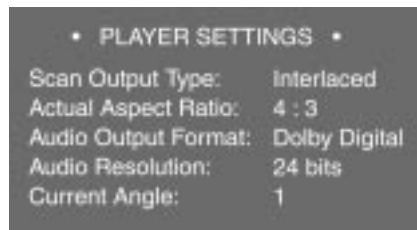

• PLAYER SETTINGS •	
Scan Output Type:	Interlaced
Actual Aspect Ratio:	4 : 3
Audio Output Format:	Dolby Digital
Audio Resolution:	24 bits
Current Angle:	1

Press the **Info Button** **11** again to remove the info menus from the screen. Note that transport functions will not work as long as any menu is on the screen.

## Program Play

Programmed play allows you to select any track, title or chapter from a DVD in the DVD 101 for playback in a specific order. This type of programming is particularly useful for parties or other situations where you want continuous playback of specific selections for a long period of time. To program the disc in the DVD 101 for playback, follow these steps:

### Program Edit

1. In Stop or Resume mode, press the **Prog Button** **30** on the remote; the Program Edit Display appears.



- If there is no programmed Title/Chapter on the playlist, the above display appears when you press the **Prog Button** **30**. The numbers below the TITLE and CHAPTER icons indicate the number of Titles on the disc and Chapters in any title selected.
2. Select a specific title by pressing the **▲** or **▼ Navigation Button** **10**, then press the **▶ Navigation Button** **10** or **Enter Button** **10** to highlight CHAPTER. You can also select a title directly by entering its number with the **Numeric Keys** **29**.
  3. Select a chapter in the same way as above, after the title containing the chapter was selected. The number of chapters, contained in each title selected, is indicated in parentheses under the CHAPTER box. When chapter is selected press the **▶ Navigation Button** **10** or **Enter Button** **10** then ADD will be highlighted automatically. Press the **Enter Button** **10** to add selected chapter onto Playlist.
  4. You can select a maximum of 50 items by repeating Steps 2 and 3.
  5. When you've completed program edit, select the **PLAY** icon and then press the **Enter Button** **10** or **Play Button** **4 17** on the remote to start program play. If you have completed program edit, but do not wish to play the program immediately, select **DONE** and then press the **Enter Button** **10** on the remote, followed by the **Play Button** **4 17** to resume normal playback.

- To start playback of a previously selected program while a disc is playing normally, press the **Prog Button** **30**. The program will play and the **PROG Indicator** **L** in the front display will light.

### Delete Program

1. To delete any programmed Title/Chapter, press the **▶** or **◀ Navigation Button** **10** on the remote to move the cursor (highlight) to the Playlist; at the same moment the **DELETE** box left of the list will be grayed out (selected automatically).
  2. Press the **▲** or **▼ Navigation Button** **10** to select the Title/Chapter to be deleted. When it is selected, press the **Enter Button** **10**; the selected Title/Chapter will be deleted. Note that the next value in the list will replace the deleted one and will be selected automatically.
- The program can be deleted completely by moving the cursor to the top of the play list, and pressing the **Enter Button** **10** for each value programmed or by turning the unit off (completely, not to Standby only) or opening the tray (see "Cancel Program Play").

### Insert Title/Chapter

Inserting titles or chapters is possible only if titles or chapters are already programmed on the Playlist and will change the order of playback.

1. Press the **Prog Button** **30** on the remote to insert Title/Chapter; the Program Edit Display appears, with all titles/chapters programmed listed in the Playlist.
2. To insert Title/Chapter, move the cursor to PLAYLIST. Then press the **▲** or **▼ Navigation Button** **10** on the remote to select location where you want to insert a Title/Chapter. It will be inserted above the location selected.

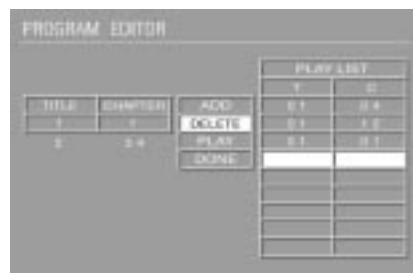

3. Move the cursor to the TITLE icon and select the title and chapter to be inserted as described in "Program Edit" above. The location where any new selections will be inserted remains highlighted.

4. Select **ADD** and press the **Enter Button** **10**. The selected Title/Chapter will be inserted.

- When you finish adding values to the Playlist and want to return to normal play mode, select **DONE** and press the **Enter Button** **10** on the remote.

### Cancel Program Play

To cancel Program Play, follow one of these steps:

1. When you open the tray, the complete program will be deleted.
2. Press the **Stop Button** **6 19** twice in the play mode. The **PROG Indicator** **L** will disappear from the display and the player will stop and return to normal mode, but the program will remain in memory and can be recalled by pressing the **Prog Button** **30** again.
3. To cancel Program Play while a program is playing, simply press the **Prog Button** **30**. Normal playback will resume and the **PROG Indicator** **L** will turn off. To return to program play from normal play, simply press the **Prog Button** **30**; the program will be played at once.

### Check a Program Without Screen

To check the contents of a Playlist using the Front-Panel Information Display only rather than the on-screen display, follow these steps:

1. If you have not already done so, activate the Program Play mode. The **PROG Indicator** **L** in the front-panel display will light. Then press the **Stop Button** **6 19** once to enter Resume mode.
2. Press the **Check Button** **31**. The first item programmed will be displayed.
3. Press the **Check Button** **31** again to step through each of the programmed items. The Program Sequence Number will appear on the far right side of the front display and the title number will appear on the left side (below TRACK).

# CD PLAYBACK

## Audio CD Playback Features

When playing audio CDs, your DVD player has the same features as a CD player, including track skip, repeat play and programmed playback. The on-screen Info Display, appearing when the **Repeat Button** **33** or **Random Button** **25** is pressed (see page 29), and the On-Screen Banner Display (shown below), appearing automatically when a CD is played, let you choose various playback features.

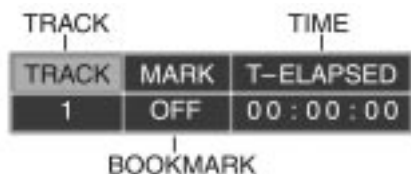

**Track:** The number shown indicates the number of the track that is currently playing.

**Bookmark:** Highlight this area and press the **Enter Button** **10** to set or go to bookmarked locations on a disc.

**Time Display Type:** This shows the type of time indication being shown: Time Elapsed or Remaining for the Current Track, Total Elapsed for the Disc, or Total Remaining for the Disc.

### Using the Banner Display

As soon as a CD is played, the Banner Display will appear automatically. To delete it from screen, press the **Status Button** **14** or **Clear Button** **32** on the remote. To display it, while the CD is playing, press the **Status Button** **14** again. The On-Screen Banner Display cannot be used in Stop mode, only in Pause or Play mode. In the display, some of the playback features are illustrated with an icon. To access a feature, press the appropriate **Navigation Buttons** **10** on the remote to highlight the icon. Each feature is described in the following pages.

**NOTE:** To see the On-Screen Banner Display, you must turn on your TV and select the appropriate Video Input.

## Selecting a Track

1. During Stop, Resume or Play mode, enter the track number directly with the **Numeric Keys** **29** on the remote. The track selected will be played at once.
2. Or press the **Status Button** **14** on the remote to see the On-Screen Banner Display on the screen if it's not there already (as it normally is in Play mode). Press the **Navigation Buttons** **10** on the remote to highlight the Track Number icon if it's not already highlighted (in Play mode this icon is highlighted automatically). Enter the Track Number using the **Numeric Keys** **29**.

- In all modes any track can be selected directly by entering its number with the **Numeric Keys** **29** on the remote, no matter whether the Status Banner is on or not.
- You can skip through tracks forward or backward by pressing the **Next/Prev. Buttons** (track skip **▶▶|**/**◀◀**) **15** **16** on the remote or the **Skip Button** (previous/next) **7** **8** on the front panel.
- In Stop mode the front display will show the number of tracks recorded on a CD (below the TRACK indicator) and the total time on disc.

## Using Bookmarks

Bookmarks are a feature of the DVD 101 that allows you to mark up to nine different points on a disc and to quickly return to those points later.

### To Enter a Bookmark, Follow These Steps:

1. While a disc is playing, press the **Status Button** **14** on the remote to see the On-Screen Banner Display (if not already shown).
2. Use the **Navigation Buttons** **10** until the MARK icon is highlighted and press the **Enter Button** **10**; the Bookmark menu appears.



3. When you reach the place on the disc you want to mark, press the **Enter Button** **10**.
4. To add marks, move the cursor with the **Navigation Button** **10** to the SET line (if it's not already there), then move the cursor to any free frame with the **Navigation Button** **10**. Press the **Enter Button** **10** when the next place on the disc you want to mark is reached.
5. Press the **Status Button** **14** or move the cursor to EXIT and press the **Enter Button** **10** to return to the On-Screen Banner Display or press the **Clear Button** **32** on the remote to make the Banner Display disappear from the screen.

### Recalling a Bookmarked Scene:

1. While playing a disc, press the **Status Button** **14** on the remote; the On-Screen Banner Display will appear.
2. Press the **Navigation Button** **10** on the remote, until the MARK icon is highlighted.
3. Press the **Enter Button** **10**.
4. The cursor automatically will highlight the first mark in the JUMP line of the Bookmark menu.



5. Use the **Navigation Buttons** **10** on the remote to select the bookmarked scene you want to activate.
6. Press the **Enter Button** **10** to go to the bookmark.
7. Press the **Status Button** **14** or move the cursor to EXIT (far right) and press the **Enter Button** **10** to return to the On-Screen Banner Display. To make the Banner Display disappear from the screen, press the **Clear Button** **32** on the remote.

**NOTE:** If all nine bookmarks are in use, you can still mark new scenes, but the previous bookmarks will be erased.

### Clearing a Bookmark

The bookmarks are cleared each time a disc is removed from the player or when the power is turned off completely (not to Standby only).

You may also clear all bookmarks by moving the cursor to CANCEL and pressing the **Enter Button** **10**.

## Selecting Time Display

The time display in the front-panel display or at the right of the On-Screen Banner Display can be selected and adjusted:

1. If the Banner Display is on-screen, press the **Navigation Button** **10** on the remote to highlight the Time section.
2. In normal operation, the elapsed time of the track being played is displayed and the On-Screen Banner Display reads T-ELAPSED.

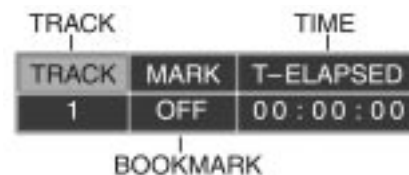

- When the TIME section is highlighted, press the **▲ Navigation Button 10** to view the time remaining on the track (T-REMAIN). Press again to view elapsed time of the disc (D-ELAPSED). Press again to view the time remaining for the disc (D-REMAIN).
- If you press the **Enter Button 10** while the Time display is highlighted, the player displays SET TIME. With the **Numeric Keys 29**, you can enter an exact time from which you wish the disc to play, then press the **Enter Button 10** or the **Play Button 4 17** to start playback from the selected point on the disc.
- To change the front-panel time display while a CD is playing without a TV screen, press the **◀ Navigation Button 10** twice. Press the **▼ Navigation Button 10** repeatedly to change time display: track time elapsed – track time remaining – disc time elapsed – disc time remaining.

## Repeat Play

With CDs the DVD 101 offers three Repeat functions that allow you to take advantage of the capacity of the unit for unattended playback:

- Repeat Disc:** Plays the complete disc repeatedly from start to finish until the disc is manually stopped. When that mode is selected, **REPEAT ALL H** will appear in the front-panel display, and REPEAT DISC will appear on-screen.
- Repeat Track:** Repeats the CD track currently being played until the disc is manually stopped. When that mode is selected, **REPEAT 1 H** will light up in the front-panel display, and REPEAT TRACK will appear on-screen.
- Repeat A-B:** Repeats any selected portion of the disc until the disc is manually stopped.

To select any Repeat mode, do the following:

- While a disc is playing, press the **Repeat Button 33** on the remote; the Repeat Display appears.



- Access the Repeat modes and their appropriate menus in the following order by pressing the **Repeat Button 33** on the remote repeatedly until the desired function is displayed. REPEAT TRACK → REPEAT DISC → REPEAT OFF

- To make the menu disappear from the screen, press the **Clear Button 32** on the remote or wait a few seconds.

- To cancel any Repeat Play function and to continue with normal play, press the **Repeat Button 33** until the Repeat Off banner appears in the on-screen display or the **REPEAT Indicator H** in the Front-Panel Information Display goes out.
- Repeat Play may be stopped and canceled by pressing the **Stop Button 6 19** twice.
- With CD, all Repeat modes are also available during Program play (see page 30). If Repeat All is selected during Program play, the complete program will be repeated rather than the disc.

## A-B Repeat Play

The Repeat A-B function allows you to select any portion of a CD and have it repeat continually until the unit is manually stopped.

To initiate a Repeat A-B playback sequence, follow these steps while a disc is playing:

- While a disc is playing, press the **A-B Button 35** on the remote when you want to choose a passage as the beginning point. The Repeat A– Display appears and **REPEAT A– K** is indicated in the front-panel display.



- Press the **A-B Button 35** again to choose the end of the passage. REPEAT A–B will appear on the screen and in the front-panel display. Repeat A-B is set and the A-B section will be played continuously.
- Press the **A-B Button 35** on the remote again so that the **REPEAT A-B Indicators K** disappear and REPEAT OFF appears on the screen to cancel the Repeat A-B mode and to play on in normal mode.
- To make the menu disappear from the screen, press the **Clear Button 32** on the remote or wait a few seconds.

**NOTE:** The A-B Repeat range may cover several tracks on the CD.

## Random Play

The Random Play function will play all of the tracks on a CD in a random order as selected by the DVD 101. Once the DVD 101 has played all of the tracks on the disc, it will stop.

- While the disc is in Stop or Resume mode, press the **Random Button 25** on the remote. The **PROGRAM EDITOR** will appear and the **RANDOM Indicator J** will light in the front-panel display. The Playlist shows the order in which tracks will be played.

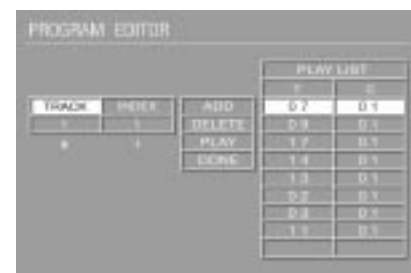

- Press the **Play Button 4 17** to begin random playback. The Program Editor on the screen will be replaced by the normal Banner Display.

- To make the Banner Display disappear from the screen, press the **Clear Button 32** on the remote.

**NOTE:** Random Play can also be started or canceled when the DVD 101 is in Play mode (without the Program Editor appearing) by pressing the **Random Button 25**. Random Play cannot be canceled during Stop or Resume mode by pressing the **Random Button 25** again. This must be done during play.

## Video Off Feature

During CD playback, some listeners may prefer to turn off the DVD 101's video circuitry. Although the video section is electrically isolated from the audio section, some users may prefer to turn the video displays off during audio playback to prevent any possibility of interference between audio and video. You may also wish to turn the video display off if you find the menu system distracting or unnecessary during CD playback.

To turn the video displays off while a CD is playing, simply press the **Video Off Button 27**. Press the button again to restore the video output. Note that the video output will automatically be restored each time the DVD 101 is turned on.

# PROGRAMMED PLAY WITH CD

## Program Play

Programmed play allows you to select any track from a CD for playback in a specific order. This type of programming is particularly useful for parties or other situations where you want continuous playback of specific selections for a long period of time. To program the disc in the DVD 101 for playback, follow these steps:

## Program Edit

1. In Stop or Resume mode, press the **Prog Button** **30** on the remote. The Program Edit Display will appear.



- If there is no programmed Track on the Playlist, the above Display appears when you press the **Prog Button** **30**. The number below the TRACK icon indicates the number of tracks on the disc.
2. Select a specific track by pressing the **▲** or **▼** **Navigation Button** **10**. Then press the **Enter Button** **10** twice. You can also select a track directly by entering its number with the **Numeric Keys** **29**. Then press the **Enter Button** **10** to add the selected track to the Playlist.



3. You can select a maximum of 50 tracks by repeating Step 2.
4. When you have completed program editing, select the PLAY icon and then press the **Enter Button** **10** or **Play Button** **17** on the remote to start program play. If you do not wish to play the program immediately, select DONE, then press the **Enter Button** **10** followed by the **Play Button** **17** to resume normal playback.

- To listen to a previously edited program during normal disc playback, press the **Prog Button** **30**. The program will play and the **PROG Indicator** **L** in the front display will light.

## Delete Program

1. To delete any programmed track while the Program Edit Display is on the screen, press the **▶** or **◀** **Navigation Button** **10** on the remote to move the cursor (highlight) to the Playlist.
  2. Press the **▲** or **▼** **Navigation Button** **10** to select the track to be deleted. When it is selected press the **Enter Button** **10**; the selected track will be deleted. The next value in the list will replace the deleted one and will be selected automatically.
- The program can be deleted completely by moving the cursor to the top of the Playlist, and pressing the **Enter Button** **10** for each value programmed or by turning the unit off completely (by the **Main Power On/Off Button** **1**) or opening the tray (see "Cancel Program Play").

## Insert Tracks

Inserting tracks is possible only if tracks are already programmed on the Playlist and will change the order of playback.

1. Press the **Prog Button** **30** on the remote to insert a track; Program Edit Display appears.
2. Move cursor to PLAYLIST and press the **▲** or **▼** **Navigation Button** **10** on the remote to select location where you want to insert a track. It will be inserted above the location selected.

3. Move the cursor to the TRACK icon and select and add the track to be inserted as described in "Program Edit" above. The location where any new selections will be inserted remains highlighted by a gray background.



- When you finish adding values to the Playlist and want to return to normal play mode, select DONE and press the **Enter Button** **10** on the remote.

## Cancel Program Play

Program Play will be canceled by following one of these steps:

1. The complete program will be deleted when you open the tray.
2. The complete program will be deleted when you turn power off completely (using the **Main Power On/Off Button** **1**).
3. Press the **Stop Button** **6** **19** twice while in play mode. Then the **PROG Indicator** **L** will disappear from the display and the player will stop and return to normal mode. The program will remain in memory and can be recalled by pressing the **Prog Button** **30**.
4. To cancel Program play while a program is playing and return to normal play, press the **Prog Button** **30**. The **PROG Indicator** **L** in the front display will turn off and the unit will turn to normal play mode.

## Checking the Program Without On-Screen Display

To check the contents of a Playlist using the Front-Panel Information Display only rather than the on-screen display, follow these steps:

1. Activate the Program Play mode, if it's not activated already, so that the **PROG Indicator** **L** in the front-panel display lights. Then press the **Stop Button** **6** **19** once (Resume mode).
2. Press the **Check Button** **31**. The first track number programmed will be displayed.
3. Press the **Check Button** **31** again to step through each of the programmed tracks. The program location number will appear on the far right side of the front display and the track number will appear on the left side.

The DVD 101 is rare among DVD players in that it is able to play back discs recorded with MP3 files. This means that you may enjoy the latest music using discs created in your computer through the high-quality audio components in your home theater system. As the way that MP3 files are recorded on discs differs from the way conventional CD audio discs are structured, MP3 playback is somewhat different from that of standard CDs.

**Important Note on MP3 Playback:** MP3 discs may contain 200 tracks or even more. To get the best overview about all tracks on the disc and their names and to select or program them comfortably use the on-screen display rather than the front-panel display. The front-panel display will only show the number and the elapsed time of the track being played.

## MP3 Disc Playback

After an MP3 disc is loaded and the tray closed, the DVD 101 will read the table of contents (TOC). At the same time a listing of all the directories on the disc (if the disc was made with several directories) and of all tracks within the root directory on the disc will appear on the video screen similar to the figure below. When any of the tracks is selected and played (see below), the name and elapsed time of the track currently played is displayed on top. The right side of the screen will initially be blank, as that is used for programming playlists for MP3 playback.



To select a directory (if any), press the ▲/▼ **Navigation Buttons 10** until the desired directory name is highlighted, then press the **Enter Button 10**. To select a track, press the ▲/▼ **Navigation Buttons 10** until the desired track name is highlighted. If the list of tracks is longer than will fit on the screen, press the ◀ **Navigation Button 10** to move the cursor to the "+10" or "-10" box on the left and press the **Enter Button 10** to jump through list of the track numbers by +10 or -10. Then press the ▶ **Navigation Button 10** to return to the list. To start the track selected on the list, press the **Enter Button 10** or **Play Button 4 17**.

During MP3 playback, some of the standard CD/DVD playback controls operate in their normal fashion:

- You may skip forward to the next track on the disc by pressing the **Next Button 8 16**.
- You may skip back to the current or previous track on the disc by pressing the **Prev Button 7 15** once or twice.
- Press the **Pause Button 5 13** to momentarily stop playback. Press the **Play Button 4 17** to resume play. Press the **Stop Button 6 19** twice to enter stop mode.
- You may search through tracks forward or in reverse by pressing the appropriate **Search Buttons 18 20** on the remote.

All other buttons (including the numeric buttons) will have no function with MP3 playback, except the **Prog Button 30** and **Clear Button 32**, which are needed for programmed playback (see below).

### NOTES ON MP3 PLAYBACK

- During MP3 playback, the front-panel display and the time indicator on the screen above the list will show the elapsed time of the track being played. Other time display options are not available with MP3 playback.
- The DVD 101 is only compatible with standard MP3-encoded discs. Other compressed-audio formats used for Internet audio downloads will not play on the DVD 101.
- Due to the differences in various versions of the MP3 format, and the many differences between the CD-R machines used to record MP3 discs on a computer, it is possible that some MP3 discs may not play on the DVD 101 even though they will work on a computer. This is normal and does not indicate a fault with the unit.
- When a multisession disc with both standard CD audio and MP3 content is in use, the DVD 101 will play only the CD audio sections of the disc.
- When an MP3 disc with multiple directories is playing, only tracks from one directory can be displayed and played at a time. Select the desired directory and press the **Play Button 4 17** to start the first track. To see and play tracks from other directories, first you must select that directory, then select the track and press the **Play Button 4 17**.

### Programmed Playback With MP3 Discs

The DVD 101 is capable of creating playlists up to 200 tracks long with the MP3 files on a properly recorded disc. To create a playback list for MP3 titles, follow these steps:

Step 1: Load a compatible MP3 disc; the MP3 Playlist Editor will appear on the screen.

Step 2: Use the ▲ or ▼ **Navigation Buttons 10** to select the directory and the first track to be programmed, as described above, and press the **Prog Button 30**. The track name and its position number in the Playlist will now appear on the right side of the screen.

Step 3: Repeat Step 2 above until all desired tracks are added to the Playlist.

Step 4: To remove a track from the Playlist, first press the ◀ or ▶ **Navigation Buttons 10** so that the highlight bar moves to the right side of the screen. Use the ▲ or ▼ **Navigation Buttons 10** to highlight the track to be deleted and press the **Clear Button 32**.

Step 5: To clear all the tracks in the Playlist, press the ◀ or ▶ **Navigation Buttons 10** until the CLEAR ALL box at the bottom of the right side of the screen is highlighted and press the **Enter Button 10**.

Step 6: To play the tracks on the list, press the ▶ **Navigation Button 10** to move the cursor to the Playlist and select the first track to be played with the ▲ or ▼ **Navigation Buttons 10**, then press the **Play Button 4 17**. All tracks on the list will be played one after another, starting with the track selected. While any track is playing, its number and elapsed time will be indicated on the front and on-screen and the name of the track will appear on top of the screen. You can skip to another programmed track with the **Next Buttons 8 16** and **Prev Buttons 7 15** any time or by selecting a track from the Playlist and pressing the **Enter Button 10** or **Play Button 4 17**.

Once a Playlist is created, it will remain available as long as the disc is not changed or the power turned off. You may play any track on the disc, not only of the program created, without erasing the Playlist by pressing the ◀ or ▶ **Navigation Buttons** to return the highlight bar to the left side of the screen and selecting the track and pressing the **Enter Button 10** or **Play Button 4 17**.

# VCD PLAYBACK

## VCD Playback

VCD, a format that predates DVD, is based on a different compression format than DVD and a recording method that is similar to CD. Although the DVD has, for the most part, replaced VCD as a format, the DVD 101 offers VCD playback so that you may play your existing library of VCD discs.

There are two versions of the VCD format: an early version which is simply called "VCD" and a later version which is called "Version 2.0" or "PBC." The DVD 101 is compatible with both forms of VCD, although playback will vary according to which version is used and the specific way in which the disc was created.

Even though VCD discs provide video, because the format is based on CD technology, the playback functions for a VCD disc are similar to CD. To play a VCD disc, place it in the DVD 101 as you would do with any other CD or DVD disc. The unit takes a few seconds to read the disc's contents; the **VCD Disc Type A** and the red **PBC Indicators** in the front-panel display will light and the disc will begin playing. However, keep in mind that the exact level of functionality for any VCD will vary widely and it is ultimately determined by the way the disc was created, not by the DVD 101, particularly if the disc has been created under VCD Version 2.0 with Playback Control (see "Playback Control").

When playing VCD discs, most standard DVD/CD playback controls are used, including Play, Stop, Pause, Resume, Track Skip Forward and Reverse, Slow Forward, Step Forward and Fast Forward or Reverse Search. The functions Slow Reverse and Step Reverse are not available with VCDs.

With VCDs you have the same access to detailed information on the disc playing or on the current player setting as with DVDs by pressing the **Info Button** on the remote once or twice. See "Information Menus" on page 26.

## Using the On-Screen Banner Display for VCD Playback

When playing VCD discs it is possible to access the disc's features using the On-Screen Banner Display as shown for CD playback on page 28. Press the **Status Button** on the remote to see the Banner Display. Note, however, that when the PBC is on, some features may be not available with that VCD.

TRACK		TIME	
TRACK	MARK	T-ELAPSED	
1	OFF	00:00:00	

BOOKMARK

Use of functions when the PBC is on will vary according to the disc type. With some VCD discs, you may select the Bookmark feature, but not with others. Note that if the disc was created with Playback Control (PBC) [see below] it is not possible to change track numbers directly.

Depending on the disc's functionality, some VCD discs allow the time display to be changed, even with PBC, as described for CD on page 28.

## Playback Control

VCD discs made under the Revision 2.0 specification will usually offer PBC playback control.

The **PBC Indicator** in the front display will turn on automatically with any VCD, when the disc is played.

With PBC, you can select titles and navigate the disc as with DVDs. However, the access to some functions may be prohibited by the PBC playback control; in that case, the prohibit icon will appear on screen.

When the VCD is made without PBC, the disc can be controlled the same as an audio CD, but direct track access by entering a number is not possible without opening the On-Screen Banner Display.

With PBC, many discs include chapter selection menus that are similar to those found on DVDs. However, on VCD discs the disc menu (if any) is accessed and controlled differently than on DVDs.

- Play will start with the first track (which may be an intro), then leading to the VCD menu (if any) automatically.
- NEXT (Skip Forward) will skip to the VCD menu from the intro (Track 1) directly.
- Once the menu options appear on the screen, make your selection by pressing the **Numeric Keys** that correspond to your desired choice. The desired selection will begin playing automatically.
- Direct number entry without any VCD menu shown on-screen has no effect – even when the Status Banner is on.

The **Menu Button** used during DVD playback is not used for VCD playback.





# DVD LANGUAGE CODES

The availability of specific languages for the main audio track or subtitles is dependent on the choices made by a disc's producer. You should always consult the disc's jacket for information on languages for any disc. In the case of some languages, you may be required to enter a code from the list below to access that language. See pages 18–20 for more information on entering language codes.

Language	Code	Language	Code	Language	Code
Abkhazian	6566	Hungarian	7285	Russian	8285
Afar	6565	Icelandic	7383	Samoan	8377
Afrikaans	6570	Indonesian	7378	Sangho	8371
Albanian	8381	Interlingua	7365	Sanskrit	8365
Ameharic	6577	Interlingue	7369	Scots Gaelic	7168
Arabic	6582	Iunpiak	7375	Serbian	8382
Armenian	7289	Irish	7165	Servo-Croatian	8372
Assamese	6583	Italian	7384	Sesotho	8384
Aymara	6588	Japanese	7465	Setswana	8478
Azerbaijani	6590	Javanese	7487	Shona	8378
Bashkir	6665	Kannada	7578	Sindhi	8368
Basque	6985	Kashmiri	7583	Singhalese	8373
Bengali; Bangla	6678	Kazakh	7575	Siswati	8383
Bhutani	6890	Kinyarwanda	8287	Slovak	8375
Bihari	6672	Kirghiz	7589	Slovenian	8376
Bislama	6673	Kirundi	8278	Somali	8379
Breton	6682	Korean	7579	Spanish	6983
Bulgarian	6671	Kurdish	7585	Sundanese	8385
Burmese	7789	Laothian	7679	Swahili	8387
Byelorussian	6669	Latin	7665	Swedish	8386
Cambodian	7577	Latvian, Lettish	7686	Tagalog	8476
Catalan	6765	Lingala	7678	Tajik	8471
Chinese	9072	Lithuanian	7684	Tamil	8465
Corsican	6779	Macedonian	7775	Tatar	8484
Croatian	7282	Malagsy	7771	Telugu	8469
Czech	6783	Malay	7783	Thai	8472
Danish	6865	Malayalam	7776	Tibetan	6679
Dutch	7876	Maltese	7784	Tigrinya	8473
English	6978	Maori	7773	Tonga	8479
Esperanto	6979	Marathi	7782	Tsonga	8483
Estonian	6984	Moldavian	7779	Turkish	8482
Faroese	7079	Mongolian	7778	Turkmen	8475
Fiji	7074	Naru	7865	Twi	8487
Finnish	7073	Nepali	7869	Ukrainian	8575
French	7082	Norwegian	7879	Urdu	8582
Frisian	7089	Occitan	7967	Uzbek	8590
Galician	7176	Oriya	7982	Vietnamese	8673
Georgian	7565	Oromo (Afan)	7977	Volapuk	8679
German	6869	Panjabi	8065	Welsh	6789
Greek	6976	Pashto, Pushto	8083	Wolof	8779
Greenlandic	7576	Persian	7065	Xhosa	8872
Guarani	7178	Polish	8076	Yiddish	7473
Gujarati	7185	Portuguese	8084	Yoruba	8979
Hausa	7265	Quechua	8185	Zulu	9085
Hebrew	7387	Rhaero-Romance	8277		
Hindi	7273	Romanian	8279		

# TROUBLESHOOTING GUIDE

## TROUBLESHOOTING GUIDE

SYMPTOM	POSSIBLE CAUSE	SOLUTION
Unit does not turn on	<ul style="list-style-type: none"><li>• <b>Main Power Switch 1</b> turned off</li><li>• No AC power</li></ul>	<ul style="list-style-type: none"><li>• Press in <b>Main Power Switch 1</b>.</li><li>• Check AC power plug and make certain any switched outlet is turned on.</li></ul>
Disc does not play	<ul style="list-style-type: none"><li>• Disc loaded improperly</li><li>• Incorrect disc type</li><li>• Invalid Region Code</li><li>• Rating is above parental preset</li></ul>	<ul style="list-style-type: none"><li>• Load disc label-side up; align the disc with the guides and place it in its proper position.</li><li>• Check to see that disc is CD, CD-R, CD-RW, VCD, MP3-CD, DVD-R and DVD-RW (standard conforming) or DVD-Movie; other types will not play.</li><li>• Use Region 1 disc only.</li><li>• Enter password to override or change rating settings (see page 19).</li></ul>
No picture	<ul style="list-style-type: none"><li>• Intermittent connections</li><li>• Wrong input</li><li>• Progressive Scan output selected</li><li>• Video Off feature active</li></ul>	<ul style="list-style-type: none"><li>• Check all video connections.</li><li>• Check input selection of TV or receiver.</li><li>• Use Progressive Scan mode only with compatible TV.</li><li>• Press <b>Video Off Button 27</b> to reactivate video circuitry (see page 29).</li></ul>
No sound	<ul style="list-style-type: none"><li>• Intermittent connections</li><li>• Incorrect digital audio selection</li><li>• DVD disc is in fast or slow mode</li><li>• Surround receiver not compatible with 96kHz PCM audio</li></ul>	<ul style="list-style-type: none"><li>• Check all audio connections.</li><li>• Check digital audio settings.</li><li>• There is no audio playback on DVD discs during fast or slow modes.</li><li>• Use analog audio outputs.</li></ul>
Picture is distorted or jumps during fast forward or reverse play	<ul style="list-style-type: none"><li>• MPEG-2 decoding</li></ul>	<ul style="list-style-type: none"><li>• It is a normal artifact of DVD playback for pictures to jump or show some distortion during rapid play.</li></ul>
Some remote buttons do not operate during DVD play; prohibited symbol  appears (see below)	<ul style="list-style-type: none"><li>• Function not permitted at this time</li></ul>	<ul style="list-style-type: none"><li>• With most DVDs, some functions are not permitted at certain times (e.g., Track Skip) or at all (e.g., direct audio track selection).</li></ul>
The OSD menu is in a foreign language	<ul style="list-style-type: none"><li>• Incorrect OSD language</li></ul>	<ul style="list-style-type: none"><li>• Change OSD language selection (see pages 19).</li></ul>
The  symbol appears	<ul style="list-style-type: none"><li>• Requested function not available at this time</li></ul>	<ul style="list-style-type: none"><li>• Certain functions may be disabled by the DVD itself during passages of a disc.</li></ul>
Picture is displayed in the wrong aspect ratio	<ul style="list-style-type: none"><li>• Incorrect match of aspect-ratio settings to disc</li></ul>	<ul style="list-style-type: none"><li>• Change aspect-ratio settings (see page 17).</li></ul>
Remote control inoperative	<ul style="list-style-type: none"><li>• Weak batteries</li><li>• Sensor is blocked</li></ul>	<ul style="list-style-type: none"><li>• Change both batteries.</li><li>• Clear path to sensor or use optional outboard remote sensor.</li></ul>
Disc will not copy to VCR	<ul style="list-style-type: none"><li>• Macrovision protection</li></ul>	<ul style="list-style-type: none"><li>• Many DVDs are encoded with Macrovision to prevent copying to VCR.</li></ul>

# TECHNICAL SPECIFICATIONS

<b>Applicable Disc:</b>	Disc formats: 5-inch (12cm) or 3-inch (8cm) DVD-Movie, Standard conforming DVD-R, DVD+R, DVD-RW, DVD+RW, VCD, CD, CD-R, MP3 or CD-RW discs Region code: DVD Movie disc with Code 1 only DVD-Layers: Single Side/Single Layer, Single Side/Dual Layer, Dual Side/Dual Layer Audio formats: Linear PCM, MPEG, Dolby Digital or DTS Audio Discs
<b>Video Signal System:</b>	NTSC
<b>Composite Video Output:</b>	1V p-p/75 ohms, sync negative polarity
<b>S-Video Output:</b>	Y/Luminance: 1V p-p/75 ohms, sync negative polarity C/Chrominance: 0.286V p-p
<b>Component Video Output:</b>	Y: 1V p-p/75 ohms, sync negative polarity Pr: 0.7V p-p/75 ohms Pb: 0.7V p-p/75 ohms
<b>Analog Audio Output:</b>	2V rms max
<b>Frequency Response:</b>	DVD (Linear PCM): 2Hz – 22kHz +0/–0.5dB (48kHz sampling) 2Hz – 44kHz +0/–0.5dB (96kHz sampling) CD: 2Hz – 20kHz +0/–0.5dB
<b>Signal/Noise Ratio (SNR):</b>	113dB (A-weighted)
<b>Dynamic Range:</b>	DVD: 100dB (18-bit)/105dB (20-bit) CD/DVD: 96dB (16-bit)
<b>THD/1kHz:</b>	DVD/CD: 0.0025%
<b>Wow &amp; Flutter:</b>	Below Measurable Limits
<b>AC Power:</b>	120VAC/60Hz
<b>Power Consumption:</b>	12 Watts (On)/20 Watts (Max)
<b>Dimensions (W x H x D):</b>	17-3/10" x 3-7/16" x 12" (440mm x 87mm x 305mm)
<b>Weight:</b>	15.4 lb (7kg)

Depth measurement includes knobs and connectors.

Height measurement includes feet and chassis.

All specifications subject to change without notice.

Harman Kardon and Power for the Digital Revolution are registered trademarks of Harman International Industries, Incorporated.

Dolby is a registered trademark of Dolby Laboratories Licensing Corporation. Manufactured under license from Dolby Laboratories. "Dolby," "Pro Logic" and the double-D symbol are registered trademarks of Dolby Laboratories. Confidential Unpublished Works. 1992-1997 Dolby Laboratories, Inc. All rights reserved.

"DTS" is a registered trademark of Digital Theater Systems, Inc.

This product incorporates copyright protection technology that is protected by method claims of certain U.S. patents and other intellectual property rights owned by Macrovision Corporation and other rights owners. Use of this copyright protection technology must be authorized by Macrovision Corporation and is intended for home and other limited viewing uses only unless otherwise authorized by Macrovision Corporation. Reverse engineering or disassembly is prohibited.

---

**harman/kardon®**

**H** A Harman International Company  
250 Crossways Park Drive, Woodbury, New York 11797  
[www.harmankardon.com](http://www.harmankardon.com)  
© 2003 Harman International Industries, Incorporated  
Part No.: WLD8.810.119-1